

Built-in EMI noise filter
Introducing the world's top class compact inverter



1-phase 240V 0.2kW to 2.2kW
 3-phase 240V 0.4kW to 15kW
 3-phase 500V 0.4kW to 15kW
 3-phase 600V 0.75kW to 15kW

New Global Standard Inverter TOSVERT™

VF-S11

To users of our inverters : Our inverters are designed to control the speeds of three-phase induction motors for general industry.

⚠ Precautions

- * Read the instruction manual before installing or operating the inverter unit and store it in a safe place for reference.
- * When using our inverters for equipment such as nuclear power control, aviation and space flight control, traffic, and safety, and there is a risk that any failure or malfunction of the inverter could directly endanger human life or cause injury, please contact our headquarters, branch, or office printed on the front and back covers of this catalogue. Special precautions must be taken and such applications must be studied carefully.
- * When using our inverters for critical equipment, even though the inverters are manufactured under strict quality control always fit your equipment with safety devices to prevent serious accident or loss should the inverter fail (such as issuing an inverter failure signal).
- * Do not use our inverters for any load other than three-phase induction motors.
- * None of Toshiba, its subsidiaries, affiliates or agents, shall be liable for any physical damages, including, without limitation, malfunction, anomaly, breakdown or any other problem that may occur to any apparatus in which the Toshiba inverter is incorporated or to any equipment that is used in combination with the Toshiba inverter. Nor shall Toshiba, its subsidiaries, affiliates or agents be liable for any compensatory damages resulting from such utilization, including compensation for special, indirect, incidental, consequential, punitive or exemplary damages, or for loss of profit, income or data, even if the user has been advised or apprised of the likelihood of the occurrence of such loss or damages.

For further information, please contact your nearest Toshiba Representative or International Operations-Producer Goods.
 The information in this brochure is subject to change without notice.

In Touch with Tomorrow
TOSHIBA

TOSHIBA CORPORATION
 INDUSTRIAL AND POWER SYSTEMS & SERVICES COMPANY
 Overseas Sales & Marketing Department
 Electrical Apparatus & Measurement Division
 1-1,Shibaura 1-chome, Minato-ku,
 Tokyo 105-8001,Japan
 Tel.: +81(0)3-3457-4911 Fax.: +81(0)3-5444-9268
 05-08 (AB)8692A (AB)

They look the same,
but if you crack the shell you can see the difference.
The VF-S11 reveals the potential and future of inverters.



Contents	
Applicable specification by each segment	3
Standard specifications	5
Connection diagram and selection of wiring devices	7
Terminal functions	8
External dimensions	9
List of parameters	10
For inverter users	13
Peripheral devices	16
Totally enclosed box type	21

VF-S11 - The easy-to-use inverter for a variety of machines and facilities



ISO-9001 certification
This product is designed and manufactured at plants that have acquired ISO-9001 certification, the worldwide quality assurance benchmark.

ISO-14001 certification
The plants that manufacture this product are registered as compliant with ISO-14001, the environmental management system.



Compatible with the World's Main Standards
(EC Directive (CE marking), UL, CSA)

For users who need large starting torque

Conveyors, hoists, stairway elevators, and other conveyance machinery often need a large torque at startup. The VF-S11 incorporates a TOSHIBA proprietary control system -- current vector calculation control -- to generate starting torque of 1Hz - 200% or more*. This provides sufficient leeway in applications that require large starting torque.

*When a TOSHIBA standard 4-pole motor is the drive source (Torque may differ according to voltage and model.)

Example of torque data

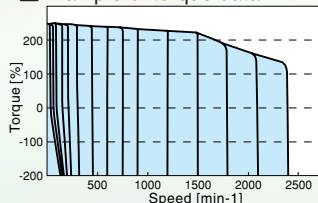

* When a TOSHIBA standard 3-phase 220V - 2.2 kW motor is driven by the VFS11-2022PM after parameters are set

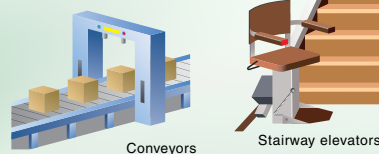

For users troubled by electromagnetic noise

Equipment such as commercial ironing boards, car washers and indoor running machines, that are used in the fields of health, medicine and welfare care, the environment and in our daily lives, cause a great deal of trouble to the surrounding area if they generate electromagnetic noise. The VF-S11 incorporates a noise filter in its compact body to drastically reduce any generated electromagnetic noise. The VF-S11 also complies with the EU EMC Directive. (See page 4.)

Example of generated noise data

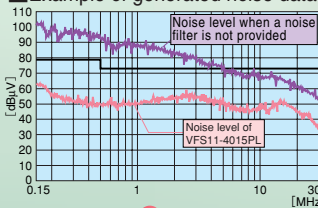

For users with limited installation space

The VF-S11 has been downsized considerably in comparison with conventional models. In addition, side-by-side installation means that you can further save space as two or more units can be installed in close proximity next to each other.

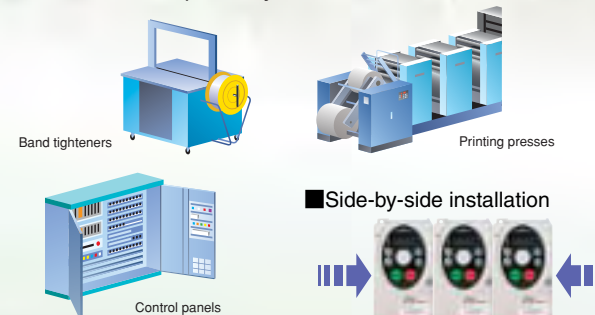

For users who place importance on maintenance

Fans, pumps, blowers, and air-conditioning equipment must be maintained on a regular basis. The VF-S11 monitors the expected replacement period of spare parts and outputs an alarm to serve as a rough guideline for when to perform maintenance. Capacitors on the main circuit have been designed to have a life of 10 years*. In addition, the VF-S11 can be used in an ambient temperature of up to 60°C and demonstrates excellent environmental resistance.

* Ambient temperature: annual average 40°C, output current: 80% of rated current, 24-hour operation 365 days per year

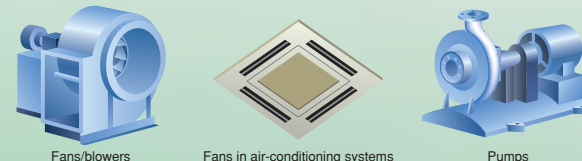

For users who need expandability

You often need to control and monitor systems by communications, for example, in building air-conditioning systems and plant line control systems.

As well as being highly expandable, the VF-S11 uses a detachable type of control terminal board, which allows you to easily mount optionally available communication boards (RS-485, DeviceNet* and LonWorks).

* DeviceNet is a registered trademarks of ODVA (Open DeviceNet Vendor Association)

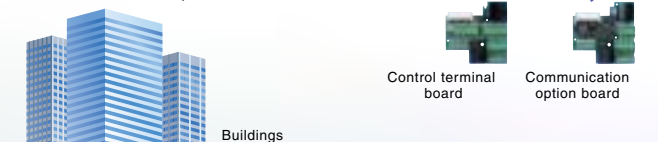

For users who need a wide capacity and range of models

For obtaining spare parts and easy maintenance for the same machinery and facilities, wouldn't you like a lineup of the same kind of inverters?

For an inverter in its class, the VF-S11 boasts a broad capacity range extending up to 15 kW. The VF-S11 also comes in a lineup of totally enclosed box types that can be used in severe installation environments subject to lots of water and dust.

Line-up

Input Voltage Class	Applicable motor (kW)										
	0.2	0.4	0.55	0.75	1.5	2.2	4.0	5.5	7.5	11	15
1-phase 240V	IP20										
	IP54*2										
3-phase 240V	IP20										
	IP54*2										
3-phase 500V	IP20										
	IP54*2										
3-phase 600V	IP20										
	IP00										

* 1: 0.55kW model is 3-phase 240V class IP20 type only.
* 2: IP54 type is possible to bring into compliance with IP55 specification.

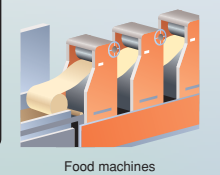

New Global Standard Inverter TOSVERT™

VF-S11

Applicable specification by each segment

The VF-S11 is provided with a wide range of useful functions for machinery and facilities in various industrial sectors and applications.

Fan & Pumps Air-conditioning systems, various fans, blowers, pumps, plumbing/sewerage systems, clean rooms, driers Noise filter Replacement alarm Life 10 years 60C* Capacity range Totally enclosed Energy savings Deceleration Restart Non-stop One-touch PID control Ground capacitor Standards	Conveyance machinery Conveyors, automatic vertical storage units, hoists, lifts, dumbwaiters High torque Compact Side-by-side Capacity range Totally enclosed Braking resistance 8 inputs 2 output functions Step width Free unit Speed control Standards
Food processing machinery Bread, confectionery, tea, and noodle making machines, rice, wheat and powder milling machines, mixers, slicers, and fruit selection machines High torque Noise filter Compact Side-by-side 60C* Capacity range Totally enclosed box type Deceleration Braking resistance 8 inputs	Packaging machinery Trimming machines, packing machines, wrapping machines, band tighteners High torque Noise filter Compact Side-by-side Detachable Communications Capacity range Totally enclosed Deceleration Braking resistance
Medical equipment Stairway elevators, nursing beds, Jacuzzis, health equipment (treadmills), medical equipment (X-ray machines) High torque Noise filter Compact Side-by-side Detachable Braking resistance Free unit Ground capacitor	Commercial facility equipment Commercial ironing boards, car washing machines, raw garbage disposal, dust collectors High torque Noise filter Compact Side-by-side Communications Capacity range Braking resistance Ground capacitor
Amusement machinery Batting machines, pinball feeders, game machines High torque Noise filter Compact Side-by-side 60C* Totally enclosed Braking resistance Ground capacitor	Semiconductor production equipment Semiconductor production equipment, LCD production equipment, electronic component production and assembly machinery High torque Noise filter Compact Side-by-side Life 10 years Capacity range Speed control Ground capacitor
Printing machinery Platemakers, binding machines, printing presses High torque Compact Side-by-side Capacity range Step width Free unit	Woodworking machinery Lumber machinery, woodworking machinery, plywood making machinery High torque Compact Capacity range Totally enclosed 500 Hz Power voltage
Agricultural machinery Rice and wheat milling machines, fruit selection machines High torque Noise filter Compact Side-by-side 60C* Totally enclosed Braking resistance Ground capacitor	Chemical machinery Mixers, extruding machines, centrifugal separators, painting machines, pulverizers High torque Compact Capacity range Restart Non-stop Pulse train
Machine tools Lathes, drilling machines, hobbing machines, grinding machines, boring machines High torque Compact Capacity range 500 Hz	Metal processing machinery Various rolling and shearing machinery, mechanical pressing, winding and take-up machines High torque Compact Capacity range Braking resistance
Textile machinery Weaving machines, knitting machines, dyeing/finishing machines, sewing machine Compact Detachable Communications 500 Hz	Panel manufacturer Control panels, special control panels Compact Side-by-side 60C* Detachable Capacity range Ground capacitor
General General related items, common items, other History Log details 28 monitors Storage	



Explanation of symbols

High torque High torque (1 Hz - 200% or more)	Capacity range Wide capacity range up to 15 kW.	8 inputs 8 logic inputs	Standards Compatible with main standards (CE, UL, CSA)
Noise filter Built-in noise filter	Totally enclosed Totally enclosed box type (IP54, IP55 compatible)	2 output functions 2 output terminal functions are assigned.	Sink/source Sink/source logic switching
Compact Small-sized, compact	Energy savings Dynamic energy saving function	Step width Variable step width setting	History History function
Side-by-side Side-by-side installation	Deceleration Dynamic deceleration time reduction	Free unit Free unit multiplication factor, bias setting	Log details Detailed information of past tripping
Replacement alarm Expected replacement period alarm for spare parts	Restart Instantaneous power interruption restart (frequency scan system)	500 Hz Max. frequency 500 Hz	28 monitors 28 monitor functions (power, watt-hour power)
Life 10 years Main circuit capacitor designed to have a life of 10 years	Non-stop Instantaneous power interruption non-stop control function	Pulse train Pulse train output	Storage Storage of user parameter settings
60°C Possible installed in an ambient temperature 60°C	One-touch One-touch fan replacement	Speed control Speed control accuracy	
Detachable Detachable terminal block	PID control PID control with wait time	Power voltage Wide power supply voltage range (240 V, 500 V)	
Communications Built-in communications options	Braking resistance Built-in braking resistor drive circuit	Ground capacitor Ground capacitor disconnection switch	

Dynamic Automatic Energy Savings

Energy savings Dynamic automatic energy savings: A new function exclusively for fans and pumps in addition to the conventional energy savings mode. With this function, you can expect considerable energy savings.

Deceleration Dynamic deceleration time reduction control: Conventional deceleration time reduction control has been further modified. With this function, you can expect a certain amount of reduction in deceleration time even without the aid of a braking resistor.

28 monitors Energy saving effect monitor: Besides monitoring of input/output power (momentary values), the effect of energy savings can be easily checked as the input/output watt-hour power (electric energy) can be monitored.

Restart Instantaneous power interruption restart function: The inverter can be restarted smoothly without any shock as it employs a frequency scan system.

Non-stop Instantaneous power interruption non-stop control: This function uses the regenerative energy from the motor to continue inverter operation when a power interruption occurs during operation. In the same way, regenerative energy can be used to decelerate the motor to a stop without the inverter running free and then stopping.

PID control PID control: Conventional PID control functions have been enhanced for even easier use. New functions are a wait time for applying a time period in which PID control is disabled at startup and a function for resetting integrated amounts.

Various Input Terminals

8 inputs 8 contact input terminals: Analog input terminals can be selected as contact inputs. This means that up to eight contact inputs can be set to support more complex settings.

8 inputs 76 menus: A variety of operation specifications are supported as functions selected from 66 menus can be individually assigned to contact input terminals.

8 inputs Use of external power supply possible: A PLC terminal is provided for input of an external +24 V power supply. This is convenient when the inverter is connected to a programmable controller. A +24 V power supply is also integrated into the inverter which can also be used for contact input.

Various Output Terminals

2 output functions 3 contact output terminals: Various outputs are provided on three terminals, relay contact (1c) output, relay contact (1a) output, and open collector output.

Pulse train Pulse train output: Open collector output is insulated from other circuits so that it can also be used as pulse train output.

2 output functions 58 menus: Functions selected from 58 menus can be individually assigned to contact output terminals. Moreover, two menus can be simultaneously assigned to a single terminal. A hold function for holding the state of an input once it turns ON is also provided. This enables inverter compatibility with various operation specifications.

2 output functions Analog output terminal: Any of 0 to 10 V, 0 to 1 mA and 4 to 20 mA can be selected. Also, data can be selected from 20 menus.

Compatibility with World's Main Standards

Standards Compatibility with main standards: All models are compatible with the World's Main Standards (EC Directive (CE marking), UL, and CSA. Some of C-tick complied models are also available.

Sink/source Sink/source logic switching: Sink or source (i.e. positive - negative) on input terminals can be easily switched by the bit switch on the circuit board.

Noise filter Built-in noise filter: A noise filter is built into all models.

Model	Built-in Filter	European EMC Directive
Single-phase models, 500 V models	High-attenuation EMI filter	Compatible on standard products
3-phase 240 V models	Standard filter	Optionally* compatible

*1. A noise reduction filter (EU-compatible) compatible with the EMC Directive is available. See page 20.

Full Lineup of Monitor and Display Functions

28 monitors Extensive monitor menus: 28 monitor values including load current and torque current can be viewed in real time.

Log details Monitor at trip: 28 momentary monitor values for when a trip occurs can be viewed. Ten monitor values are stored in memory for the last four inverter operations, which is effective in pin-pointing the cause of a trip.

Storage Storage of user parameter settings: All parameter settings made by the user can be stored in memory. Stored parameters can be immediately called even they have been changed.

History History function: This function is for displaying the latest five changes made to parameter settings. This is displayed in the top menu (AUH), which is handy when parameters are frequently changed or repeatedly adjusted.

Free unit Free unit display: Bias can also be set in addition to the multiplication factor in the free unit display. This display shows speed of rotation, line speed and other units in addition to frequency.

Step width Variable step width setting: The change increment of the frequency when an arrow key on the panel is pressed can be set as desired. For example, this is convenient when you want to change the frequency in 10 Hz increments each time that a key is pressed.

Safe Maintenance

One-touch One-touch fan replacement: The cooling fan, one of the service parts, can be easily removed for replacement. The fan, of course, is designed to last a long time as it has a temperature-based ON/OFF control function.

Ground capacitor Ground capacitor disconnection switch: Even when current leakage is a problem, it is possible to reduce current leakage easily with a ground condenser cutoff switch. (Only on single-phase 240 V models and 3-phase 500 V models)

Extensive Communication Functions

Detachable Built-in communications option board: The detachable terminal block board can be detached and swapped with various internal option boards. Communications option boards including RS-485, DeviceNET and LonWorks are available.

Communications Communications protocol: TOSHIBA inverter protocol and Modbus-RTU protocol are supported. The inverter can also be connected directly by communications to touch panels made by Digital Electronics Corporation.

Communications Block communications: Block read/write functions have been added on as communications methods to simplify high-speed transmission of instructions and monitoring. Inverter-to-inverter communications is also supported, which enables master/slave control on just inverters without the aid of a host controller.

Other Features

Power voltage Wide power supply voltage range: 200 to 240 V range on 200 V class models, and 380 to 500 V range on 400 V class models are supported.

Speed control Speed control accuracy: Speed control accuracy is improved by high startup torque and current vector calculation control, a TOSHIBA proprietary control system.

500 Hz Output frequency: The VF-S11 can be used in a wide range of applications as its maximum output frequency is 500 Hz.

Braking resistance Built-in braking resistor drive circuit: A drive circuit for an external braking resistor is integrated into all models to enable large regenerative energy loads to be stopped in a short time.

Applicable specification by each segment

Applicable specification by each segment

Standard specifications

3-phase 240V

Item		Specification									
Input voltage class		3-phase 240V									
Applicable motor (kW)		0.4	0.55	0.75	1.5	2.2	4.0	5.5	7.5	11	15
Rating	Type	VFS11									
	Form	2004PM	2005PM	2007PM	2015PM	2022PM	2037PM	2055PM	2075PM	2110PM	2150PM
	Capacity (kVA) Note 1)	1.3	1.4	1.8	3.0	4.2	6.7	10	13	21	25
	Rated output current (A) Note 2)	3.3 (3.3)	3.7 (3.3)	4.8 (4.4)	8.0 (7.9)	11.0 (10.0)	17.5 (16.4)	27.5 (25.0)	33 (33)	54 (49)	66 (60)
	Output voltage Note 3)	3-phase 200V to 240V									
Overload current rating		150%-60 seconds, 200%-0.5 second Note 4)									
Power supply	Voltage-frequency	3-phase 200V to 240V - 50/60Hz									
	Allowable fluctuation	Voltage + 10%, -15% Note 5), frequency ±5%									
Protective method		IP20 Enclosed type (JEM1030)									
Cooling method		Self-cooling					Forced air-cooled				
Color		Munsel 5Y-8/0.5									
Built-in filter		Basic filter Note 7)									

3-phase 500V

Item		Specification									
Input voltage class		3-phase 500V									
Applicable motor (kW)		0.4	0.75	1.5	2.2	4.0	5.5	7.5	11	15	
Rating	Type	VFS11									
	Form	4004PL	4007PL	4015PL	4022PL	4037PL	4055PL	4075PL	4110PL	4150PL	
	Capacity (kVA) Note 1)	1.1	1.8	3.1	4.2	7.2	11	13	21	25	
	Rated output current (A) Note 2)	1.5 (1.5)	2.3 (2.1)	4.1 (3.7)	5.5 (5.0)	9.5 (8.6)	14.3 (13.0)	17.0 (17.0)	27.7 (25.0)	33 (30)	
	Output voltage Note 3)	3-phase 380V to 500V									
Overload current rating		150%-60 seconds, 200% -0.5 second Note 4)									
Power supply	Voltage-frequency	3-phase 380V to 500V - 50/60Hz									
	Allowable fluctuation	Voltage + 10%, -15% Note 5), frequency ±5%									
Protective method		IP20 Enclosed type (JEM1030)									
Cooling method		Forced air-cooled									
Color		Munsel 5Y-8/0.5									
Built-in filter		High-attenuation EMI filter Note 8)									

1-phase 240V

Item		Specification												
Input voltage class		1-phase 240V						3-phase 600V Note 6)						
Applicable motor (kW)		0.2	0.4	0.75	1.5	2.2	0.75	1.5	2.2	4.0	5.5	7.5	11	15
Rating	Type	VFS11S						VFS11						
	Form	2002PL	2004PL	2007PL	2015PL	2022PL	6007P	6015P	6022P	6037P	6055P	6075P	6110P	6150P
	Capacity (kVA) Note 1)	0.6	1.3	1.8	3.0	4.2	1.7	2.7	3.9	6.1	9.0	11	17	22
	Rated output current (A) Note 2)	1.5 (1.5)	3.3 (3.3)	4.8 (4.4)	8.0 (7.9)	11.0 (10.0)	1.7 (1.5)	2.7 (2.4)	3.9 (3.5)	6.1 (5.5)	9.0 (8.1)	11.0 (9.9)	17.0 (15.3)	22.0 (19.8)
	Output voltage Note 3)	3-phase 200V to 240V						3-phase 525V to 600V						
Overload current rating		150%-60 seconds, 200%-0.5 second Note 4)						150%-60 seconds, 200%-0.5 second Note 4)						
Power supply	Voltage-frequency	1-phase 200V to 240V - 50/60Hz						3-phase 525V to 600V - 50/60Hz						
	Allowable fluctuation	Voltage + 10%, -15% Note 5), frequency ±5%						Voltage + 10%, -15% Note 5), frequency ±5%						
Protective method		IP20 Enclosed type (JEM1030)						IP20 Enclosed type (JEM1030)						
Cooling method		Self-cooling			Forced air-cooled			Forced air-cooled						
Color		Munsel 5Y-8/0.5						Munsel 5Y-8/0.5						
Built-in filter		High-attenuation EMI filter Note 8)						No filter						

Note 1. Capacity is calculated at 220V for the 240V class, at 440V for the 500V class and at 575V for the 600V models.

Note 2. Indicates rated output current setting when the PWM carrier frequency (parameter F300) is 4kHz or less.

Note 3. Maximum output voltage is the same as the input voltage.

Note 4. May differ according to voltage and model.

Note 5. ±10% when the inverter is used continuously (load of 100%).

Note 6. If you are using 600V model, be sure to connect an input reactor (ACL).

Note 7. Built-in standard filter: Core and capacitors With RFI noise filter option: Complies EN55011 Class A Group 1 (Max.5m*) and Class B Group 1 (Max.1m*)

* Length of motor connecting cable.

Note 8. Built-in high-attenuation EMI filter: Complies EN55011 Class A Group 1 (Max.5m*) With RFI noise filter option: Complies EN55011 Class B Group 1 (Max.20m*) and Class A Group 1 (Max.50m*)

* Length of motor connecting cable.

Note 9. Above 40°C: Remove the protective seal from the top of the inverter. Above 50°C: Remove the seal from the top of the inverter and use the inverter with the rated output current reduced.

Note 10. If inverters are installed side by side (with no sufficient space left between them) installation: Remove the seal from the top of each inverter.

When installing the inverter where the ambient temperature will rise above 40°C, remove the seal from the top of the inverter and use the inverter with the rated output current reduced.

Common specification

Item	Specification	
Principal control functions	Control system	Sinusoidal PWM control
	Rated output voltage	Adjustable within the range of 50 to 600V by correcting the supply voltage (not adjustable above the input voltage)
	Output frequency range	0.5 to 500.0Hz, default setting: 0.5 to 80Hz, maximum frequency: 30 to 500Hz
	Minimum setting steps of frequency	0.01 Hz: operation panel setting, 0.1 Hz: analog input (when the max. frequency is 100Hz).
	Frequency accuracy	Digital setting: within ±0.01% of the max. frequency (-10 to +60°C) Analog setting: within ±0.5% of the max. frequency (25°C ±10°C)
	Voltage/frequency characteristics	V/f constant, variable torque, automatic torque boost, vector control, automatic energy-saving, dynamic automatic energy-saving control. Auto-tuning. Base frequency (25 - 500Hz) adjusting to 1 or 2, torque boost (0 - 30%) adjusting to 1 or 2, adjusting frequency at start (0.5 - 10Hz)
	Frequency setting signal	Potentiometer on the front panel, external frequency potentiometer (connectable to a potentiometer with a rated impedance of 1 - 10kΩ), 0 - 10Vdc (input impedance: VIA/VIB=30kΩ), 4 - 20mAdc (input impedance: 250Ω).
	Terminal board base frequency	The characteristic can be set arbitrarily by two-point setting. Possible to set individually for three functions: analog input (VIA and VIB) and communication command.
	Frequency jump	Three frequencies can be set. Setting of the jump frequency and the range.
	Upper- and lower-limit frequencies	Upper-limit frequency: 0 to maximum frequency, lower-limit frequency: 0 to upper-limit frequency
PWM carrier frequency	Adjustable within a range of 2.0 to 16.0Hz (default: 12kHz).	
PID control	Setting of proportional gain, integral gain, differential gain and control wait time. Checking whether the amount of processing amount and the amount of feedback agree.	
Operation specifications	Acceleration/deceleration time	Selectable from among acceleration/deceleration times 1, 2 or 3 (0.0 to 3200 sec.). Automatic acceleration/deceleration function. S-pattern 1 or 2, and S-pattern value adjustable. Forced rapid deceleration and dynamic rapid deceleration function.
	DC braking	Braking start-up frequency: 0 to maximum frequency, braking rate: 0 to 100%, braking time: 0 to 20 seconds, emergency DC braking, motor shaft fixing control
	Dynamic braking	Control and drive circuit is built in the inverter with the braking resistor outside (optional).
	Input terminal function (programmable)	Possible to select from 76 functions, such as forward/reverse run signal input, jog run signal input, operation base signal input and reset signal input, to assign to 8 input terminals. Logic selectable between sink and source.
	Output terminal functions (programmable)	Possible to select from 58 functions, such as upper/lower limit frequency signal output, low speed detection signal output, specified speed reach signal output and failure signal output, to assign to FL relay output, open collector output and RY output terminals.
	Forward/reverse run	The RUN and STOP keys on the operation panel are used to start and stop operation. The switching between forward run and reverse run can be done from one of the three control units: operation panel, terminal board and external control unit.
	Jog run	Jog mode, if selected, allows jog operation from the operation panel or the terminal board.
	Preset speed operation	Base frequency + 15-speed operation possible by changing the combination of 4 contacts on the terminal board.
	Retry operation	Capable of restarting automatically after a check of the main circuit elements in case the protective function is activated. 10 times (Max.) (selectable with a parameter)
	Various prohibition settings	Possible to write-protect parameters and to prohibit the change of panel frequency settings and the use of operation panel for operation, emergency stop or resetting.
Protective function	Regenerative power ride-through control	Possible to keep the motor running using its regenerative energy in case of a momentary power failure.
	Auto-restart operation	In the event of a momentary power failure, the inverter reads the rotational speed of the coasting motor and outputs a frequency appropriate to the rotational speed in order to restart the motor smoothly. This function can also be used when switching to commercial power.
	Drooping function	When two or more inverters are used to operate a single load, this function prevents load from concentrating on one inverter due to unbalance.
	Override function	The sum of two analog signals (VIA/VIB) can be used as a frequency command value.
	Failure detection signal	1c-contact output: (250Vac-0.5A-cos φ =0.4)
	Protective function	Stall prevention, current limitation, over-current, output short circuit, over-voltage, over-voltage limitation, undervoltage, ground fault, power supply phase failure, output phase failure, overload protection by electronic thermal function, armature over-current at start-up, load side over-current at start-up, over-torque, undercurrent, overheating, cumulative operation time, life alarm, emergency stop, braking resistor over-current/overload, various pre-alarms
	Electronic thermal characteristic	Switching between standard motor and constant-torque VF motor, switching between motors 1 and 2, setting of overload trip time, adjustment of stall prevention levels 1 and 2, selection of overload stall
	Reset function	Function of resetting by closing contact 1a or by turning off power or the operation panel. This function is also used to save and clear trip records.
	Alarms	Stall prevention, overvoltage, overload, under-voltage, setting error, retry in process, upper/lower limits
	Causes of failures	Over-current, overvoltage, overheating, short-circuit in load, ground fault, overload on inverter, over-current through arm at start-up, over-current through load at start-up, CPU fault, EEPROM fault, RAM fault, ROM fault, communication error. (Selectable: Over-current through braking resistor/overload, emergency stop, under-voltage, low voltage, over-torque, motor overload, output open-phase)
Display function	Monitoring function	Operation frequency, operation frequency command, forward/reverse run, output current, voltage in DC section, output voltage, torque, torque current, load factor of inverter, integral load factor of PBR, input power, output power, information on input terminals, information on output terminals, version of CPU1, version of CPU2, version of memory, PID feedback amount, frequency command (after PID), integral input power, integral output power, rated current, causes of past trips 1 through 4, information on life alarm, cumulative operation time
	Past trip monitoring function	Stores data on the past four trips: number of trips that occurred in succession, operation frequency, direction of rotation, load current, input voltage, output voltage, information on input terminals, information on output terminals, and cumulative operation time when each trip occurred.
	Output for frequency meter	Analog output (1mAdc full-scale DC ammeter or 7.5Vdc full-scale DC voltmeter/rectifier type AC voltmeter, 4 to 20mA/O to 20mA output)
	4-digit 7-segments LED	Frequency: inverter output frequency. Alarm: stall alarm "C", overvoltage alarm "P", overload alarm "L", overheat alarm "H". Status: inverter status (frequency, cause of activation of protective function, input/output voltage, output current, etc.) and parameter settings. Free-unit display: arbitrary unit (e.g. rotating speed) corresponding to output frequency.
	Indicator	Lamps indicating the inverter status by lighting, such as RUN lamp, MON lamp, PRG lamp, % lamp, Hz lamp, frequency setting potentiometer lamp, UP/DOWN key lamp and RUN key lamp. The charge lamp indicates that the main circuit capacitors are electrically charged.
Environments	Use environments	Indoor, altitude: 1000m (Max.), not exposed to direct sunlight, corrosive gas, explosive gas / vibration (less than 5.9m/s ²) (10 to 55Hz)
	Ambient temperature	-10 to +60°C Note 9,10)
	Storage temperature	-25 to +70°C
	Relative humidity	20 to 93% (free from condensation and vapor).

Contents of the product code

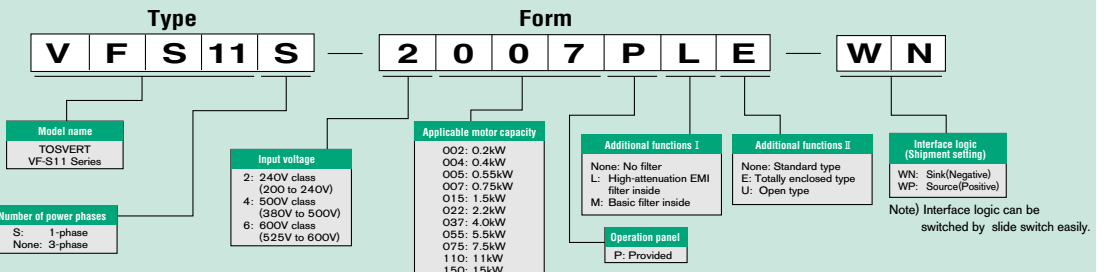

Connection diagram and selection of wiring devices

Standard connection diagram

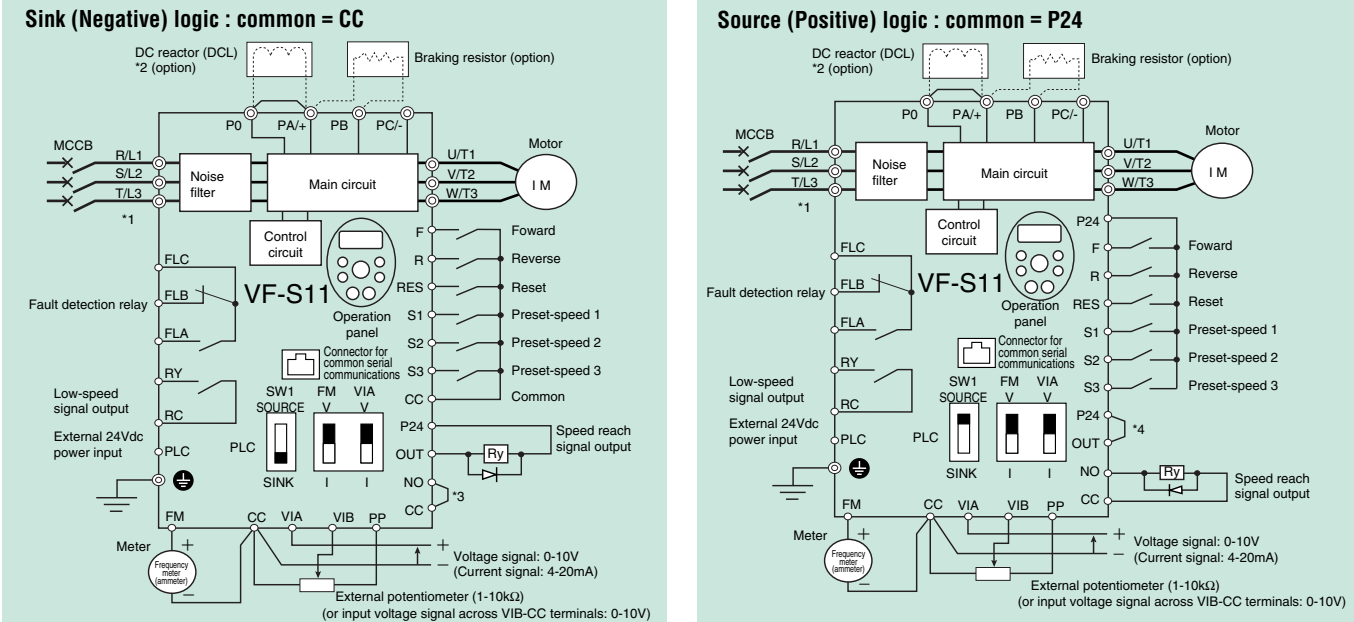

Main circuit power supply
 240V class: three-phase 200-240V -50/60Hz
 500V class: three-phase 380-500V -50/60Hz
 600V class: three-phase 525-600V -50/60Hz

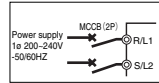

*1: The T/L3 terminal not provided for signal-phase models. Use the R/L1 and S/L2 terminal as input terminals.
 *2: The inverter came with the PO and the PA/+ terminals shorted by means of a shorting bar. Before installing the DC reactor (DCL), remove the bar.
 *3: When using the OUT output terminal in sink logic mode, short-circuit the NO and CC terminals.
 *4: When using the NO output terminal in source logic mode, short-circuit the P24 and OUT terminals.

wiring devices

Voltage class	Capacity applicable motor (kW)	Inverter model	Molded-case circuit breaker (MCCB) Earth leakage circuit breaker (ELCB)		Magnetic contactor (MC)	Overload relay (Th-Ry)	Wire size (mm ²)			
			Rated current(A) Note 8)	Rated current(A) Note 8)			Adjusted current (A) (For reference)	Main circuit (mm ²) Note 4,8)	DC reactor (optional)(mm ²)	Braking resistor (optional)(mm ²)
3-phase 240V class	0.4	VFS11-2004PM	5(5)	9(9)	2.3	2.0(2.0)	1.25	2.0	3.5	
	0.55	VFS11-2005PM	10(5)	9(9)	2.7	2.0(2.0)	2.0	2.0	3.5	
	0.75	VFS11-2007PM	10(5)	9(9)	3.6	2.0(2.0)	2.0	2.0	3.5	
	1.5	VFS11-2015PM	15(10)	9(9)	6.8	2.0(2.0)	2.0	2.0	3.5	
	2.2	VFS11-2022PM	20(15)	12(12)	9.3	2.0(2.0)	2.0	2.0	3.5	
	4.0	VFS11-2037PM	30(30)	25(18)	15	3.5(2.0)	2.0	2.0	3.5	
	5.5	VFS11-2055PM	50(40)	32(25)	22	5.5(2.0)	3.5	5.5	5.5	
	7.5	VFS11-2075PM	60(50)	38(38)	28	8.0(5.5)	5.5	5.5	8.0	
3-phase 500V class	11	VFS11-2110PM	100(75)	65(50)	44	14(8.0)	8.0	5.5	14	
	15	VFS11-2150PM	125(100)	80(65)	57	14(14)	14	5.5	14	
	0.4	VFS11-4004PL	5(5)	9(9)	1.0	2.0(2.0)	2.0	2.0	3.5	
	0.75	VFS11-4007PL	5(5)	9(9)	1.6	2.0(2.0)	2.0	2.0	3.5	
	1.5	VFS11-4015PL	10(10)	9(9)	3.6	2.0(2.0)	2.0	2.0	3.5	
	2.2	VFS11-4022PL	15(10)	9(9)	5.0	2.0(2.0)	2.0	2.0	3.5	
	4.0	VFS11-4037PL	20(15)	12(9)	6.8	2.0(2.0)	2.0	2.0	3.5	
	5.5	VFS11-4055PL	30(20)	18(18)	11	2.0(2.0)	2.0	2.0	3.5	
1-phase 240V class	7.5	VFS11-4075PL	30(30)	25(18)	15	3.5(2.0)	2.0	2.0	3.5	
	11	VFS11-4110PL	50(40)	32(25)	22	5.5(2.0)	3.5	2.0	5.5	
	15	VFS11-4150PL	60(50)	38(38)	28	8.0(5.5)	5.5	2.0	8.0	
	0.2	VFS11S-2002PL	5(5)	9(9)	1.3	2.0(2.0)	2.0	2.0	3.5	
	0.4	VFS11S-2004PL	10(5)	9(9)	2.3	2.0(2.0)	2.0	2.0	3.5	
	0.75	VFS11S-2007PL	15(10)	9(9)	3.6	2.0(2.0)	2.0	2.0	3.5	
	1.5	VFS11S-2015PL	20(15)	18(12)	6.8	2.0(2.0)	2.0	2.0	3.5	
	2.2	VFS11S-2022PL	30(30)	25(18)	9.3	2.0(2.0)	2.0	2.0	3.5	
3-phase 600V class	0.75	VFS11-6007P	5(5)	9(9)	1.0	2.0(2.0)	2.0	2.0	3.5	
	1.5	VFS11-6015P	10(10)	9(9)	1.6	2.0(2.0)	2.0	2.0	3.5	
	2.2	VFS11-6022P	10(10)	9(9)	3.6	2.0(2.0)	2.0	2.0	3.5	
	4.0	VFS11-6037P	15(15)	12(12)	5.0	2.0(2.0)	2.0	2.0	3.5	
	5.5	VFS11-6055P	20(20)	18(18)	6.8	2.0(2.0)	2.0	2.0	3.5	
	7.5	VFS11-6075P	30(30)	25(25)	11	2.0(2.0)	2.0	2.0	3.5	
	11	VFS11-6110P	30(30)	25(25)	15	3.5(3.5)	3.5	2.0	3.5	
	15	VFS11-6150P	40(40)	33(33)	22	5.5(5.5)	5.5	2.0	3.5	

- Note) 1. Be sure to attach surge killer to the exciting coil of the relay and the magnetic contactor.
 2. 500V and 600V class: For the operation and control circuit, regulate the voltage at 240V or less with a step-down transformer.
 3. When using the auxiliary contacts 2a of the magnetic contactor MC for the control circuit, connect the contacts 2a in parallel to increase reliability.
 4. Size of the wires connected to the input terminals R, S and T and the output terminals U, V and W when the length of each wire does not exceed 30m.
 5. For the control circuit, use shielded wires 0.75 mm² or more in diameter.
 6. For grounding, use a cable with a size equal to or larger than the above.
 7. The wire sizes specified in the above table apply to HIV wires (copper wires shielded with an insulator with a maximum allowable temperature of 75°C) used at an ambient temperature of 50°C or less.
 8. The numeric values in parentheses refer to the sizes of wires to be used when a DC reactor is connected.

Terminal functions

Main circuit terminal functions

Terminals symbol	Terminal function
	Grounding terminal for connecting inverter. There are 3 terminals in total. 2 terminals in the terminal board, 1 terminal in the cooling fin.
R/L1, S/L2, T/L3	240V class: single-phase 200~240V-50/60Hz three-phase 200~240V-50/60Hz 500V class: three-phase 380~500V-50/60Hz 600V class: three-phase 525~600V-50/60Hz * Single-phase input: R/L1 and S/L2 terminals
U/T1, V/T2, W/T3	Connect to a (three-phase induction) motor.
PA/+, PB	Connect to braking resistors. Change parameters <i>F304, F305, F308, F309</i> if necessary.
PC/-	This is a negative potential terminal in the internal DC main circuit. DC common power can be input across the PA/+ terminals (positive potential).
PO, PA/+	Terminals for connecting a DC reactor (DCL: optional external device). Shorted by a short bar when shipped from the factory. Before installing DCL, remove the short bar.

Control circuit terminal functions

Terminal symbol	Function	Electrical specifications	Wire size	
F	Shorting across F-CC causes forward rotation; open causes slowdown and stop.	Dry contact input 24Vdc - 5mA or less	Solid wire : 0.3 to 1.5 (mm ²) Stranded wire : 0.3 to 1.5 (mm ²) (AWG22 to 16) Sheath strip length : 6 (mm)	
R				Shorting across R-CC causes reverse rotation; open causes slowdown and stop.
RES				Shorting across RES-CC causes a held reset when the inverter protector function is operating. Note that when the inverter is operating normally, it will not operate even if there is a short across RES-CC.
S1	Shorting across S1-CC causes preset speed operation.	*Sink/Source/ PLC selectable using SW		
S2				Shorting across S2-CC causes preset speed operation.
S3				Shorting across S3-CC causes preset speed operation.
PLC	External 24Vdc power input	(Insulation resistance: 50Vdc)		
CC	Control circuit's equipotential terminal (sink logic). 3 common terminals for input/output.			
PP	Power output for analog input setting.	10Vdc (permissible load current: 10mA)		
VIA	Multifunction programmable analog input. Standard default setting: 0-10Vdc input and 0-60Hz frequency. The function can be changed to 4-20 mA (0-20 mA) current input by flipping the VIA slide switch to the I position.	10Vdc (internal impedance: 30kΩ) 4~20mA (Internal impedance: 250Ω)		
VIB	Multifunction programmable analog input. Standard default setting: 0-10Vdc input and 0-50Hz (50Hz setting) or 0-60Hz (60Hz setting) frequency.	10Vdc (internal impedance: 30kΩ)		
FM	Multifunction programmable analog output. Standard default setting: output frequency. Connect a 1mA full-scale ammeter or 7.5Vdc (10Vdc)-1mA full-scale voltmeter. The function can be changed to 0-20mA (4-20mA) current output by flipping the FM slide switch to the I position.	1mA full-scale DC ammeter or 7.5Vdc 1mA full-scale DC voltmeter 0-20mA (4-20mA) full-scale DC ammeter		
P24	When the source logic is used, a common terminal 24Vdc is connected.	24Vdc - 100mA		
OUT NO	Multifunction programmable open collector output. Standard default settings detect and output speed reach signal output frequencies. The NO terminal is an isoelectric output terminal. It is insulated from the CC terminal. These terminals can also be used as multifunction programmable pulse train output terminals.	Open collector output: 24Vdc - 50mA Pulse train output 10mA or more		
RC RY	Multifunction programmable relay contact output. Contact ratings: 250Vac - 2A (cosφ = 1), 30Vdc - 1A, 250Vac - 1A (cosφ = 0.4). Standard default settings detect and output low-speed signal output frequencies.	250Vac - 1A: at resistance load 30Vdc - 0.5A, 250Vac - 0.5A (cosφ = 0.4)		
FLA FLB FLC	Multifunction programmable relay contact output. Contact ratings: 250Vac-1A (cosφ = 1), 30Vdc-0.5A, 250Vac-0.5A (cosφ = 0.4). Detects the operation of the inverter's protection function. Contact across FLA-FLC is closed and FLB-FLC is opened during protection function operation.	250Vac - 1A: at resistance load 30Vdc - 0.5A, 250Vac - 0.5A (cosφ = 0.4)		

- Note 1: By changing parameter setting, this terminal can also be used as a multifunction programmable contact input terminal. When the inverter is used in a sink logic configuration, a resistor (4.7kΩ at 0.5W) should be inserted between the P24 and VIA/VIB terminals. Also, the slide switch for the VIA terminal needs to be turned to the V position.
 Note 2: Multifunction output terminals to which two different functions can be assigned.

Terminal functions

External dimensions

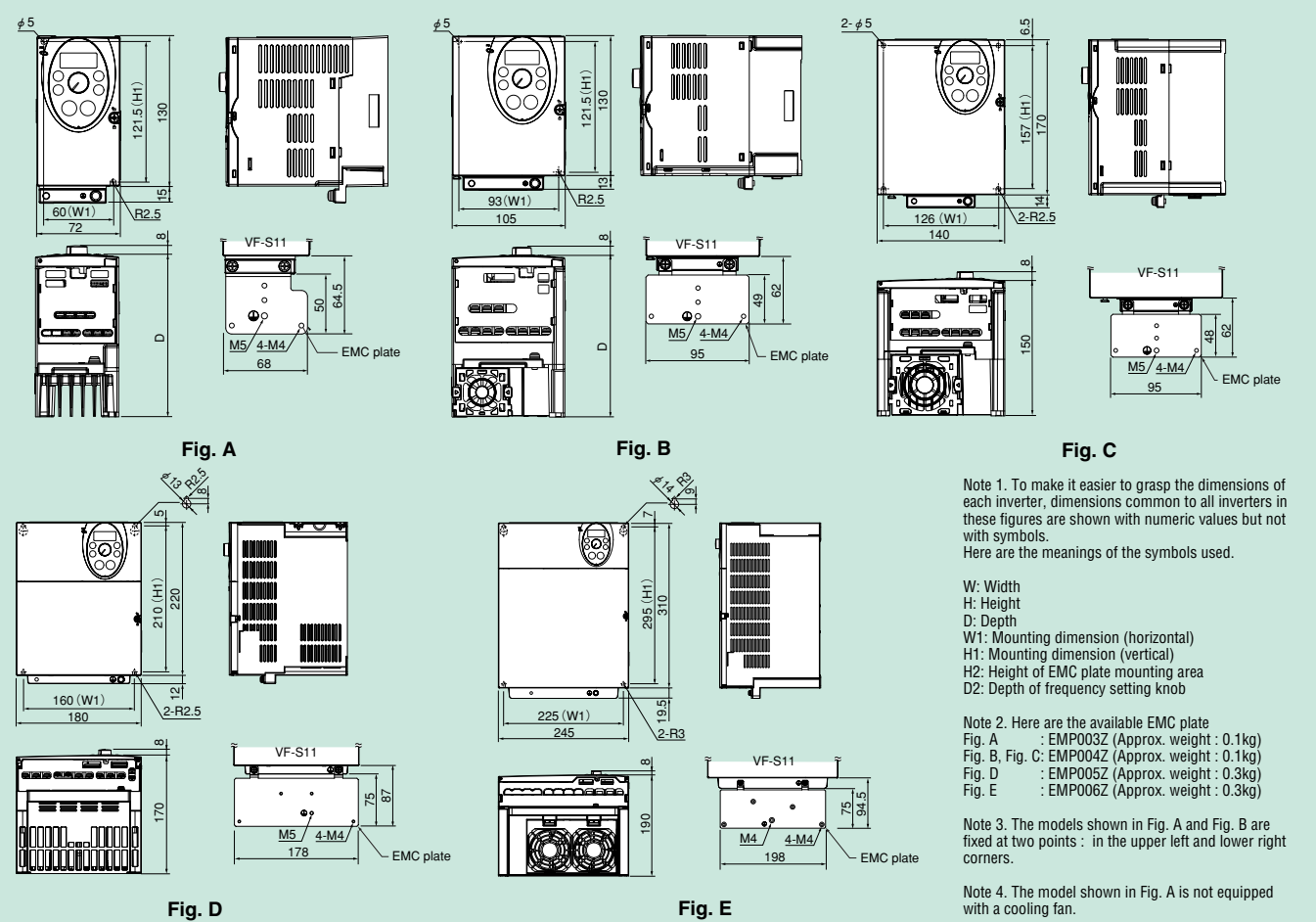

Input voltage	Applicable motor (kW)	Type	Dimensions (mm)							Drawing	Approx. weight (kg)
			W	H	D	W1	H1	H2	D2		
3-phase 240V	0.4	VFS11-2004PM	72	130	120	60	121.5	15	8	A	0.9
	0.55	VFS11-2005PM			130						1.1
	0.75	VFS11-2007PM			130						1.1
	1.5	VFS11-2015PM	105	130	130	93	121.5	13			1.2
	2.2	VFS11-2022PM			150						1.3
	4.0	VFS11-2037PM	140	170	150	126	157	14			2.2
	5.5	VFS11-2055PM	180	220	170	160	210	12			4.8
	7.5	VFS11-2075PM									4.9
	11	VFS11-2110PM									9.3
15	VFS11-2150PM	245	310	190	225	295	19.5	9.6			
3-phase 500V	0.4	VFS11-4004PL	105	130	150	93	121.5	13	8	B	1.4
	0.75	VFS11-4007PL									1.5
	1.5	VFS11-4015PL									1.5
	2.2	VFS11-4022PL	140	170	150	126	157	14			2.3
	4.0	VFS11-4037PL									2.5
	5.5	VFS11-4055PL	180	220	170	160	210	12			5.0
	7.5	VFS11-4075PL									5.1
	11	VFS11-4110PL									9.6
	15	VFS11-4150PL	245	310	190	225	295	19.5			9.6
1-phase 240V	0.2	VFS11S-2002PL	72	130	130	60	121.5	15	8	A	1.0
	0.4	VFS11S-2004PL			140						1.0
	0.75	VFS11S-2007PL			140						1.2
	1.5	VFS11S-2015PL	105	130	150	93	121.5	13			1.4
	2.2	VFS11S-2022PL	140	170	150	126	157	14			2.2
3-phase 600V	0.75	VFS11-6007P	105	130	150	93	121.5	13	8	B	1.3
	1.5	VFS11-6015P									1.3
	2.2	VFS11-6022P	140	170	150	126	157	14			2.1
	4.0	VFS11-6037P									2.2
	5.5	VFS11-6055P	180	220	170	160	210	12			4.7
	7.5	VFS11-6075P									4.7
	11	VFS11-6110P									8.8
15	VFS11-6150P	245	310	190	225	295	19.5	8.8			

List of parameters

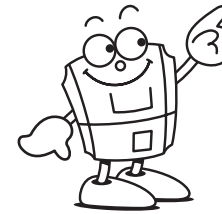

What are parameters?

Each "setting item" that determines the control (operation) of an inverter is called a parameter. For example, the connection meter selection parameter (title *FNSL*) is adjusted to set the connection meter, the acceleration time parameter (title *RCC*) is adjusted to change the acceleration time, and the maximum frequency parameter (title *FH*) is adjusted to modify the maximum frequency. For the function you want to use, check the necessary parameter(s).

Basic parameters

● Operation frequency parameter

Title	Function	Adjustment range	Default setting	Remarks
<i>FC</i>	Operation frequency of operation panel	<i>LL - UL</i>	0.0	

● Four automatic functions

Title	Function	Adjustment range	Default setting	Remarks
<i>RUH</i>	History function	Displays parameters in groups of five in the reverse order to that in which their settings were changed. * (Possible to edit)	—	
<i>RU1</i>	Automatic acceleration/ deceleration	0: Invalid (manual) 1: Automatic 2: Automatic (only at acceleration)	0	
<i>RU2</i>	Torque boost setting macro function	0: Invalid 1: Automatic torque boost + auto-tuning 2: Vector control + auto-tuning 3: Energy saving + auto-tuning	0	
<i>RU4</i>	Parameter setting macro function	0: Invalid 1: Coast stop 2: 3-wire operation 3: External input UP/DOWN setting 4: 2-20 mA current input operation	0	

● Other basic parameters

Title	Function	Adjustment range	Default setting	Remarks
<i>CND</i>	Command mode selection	0: Terminal board 1: Operation panel (Extension panel)	1	
<i>FND</i>	Frequency setting mode selection 1	0: Built-in potentiometer 1: VIA 2: VIB 3: Operation panel (Extension panel) 4: Serial communication 5: UP/DOWN from external contact 6: VIA + VIB (Override)	0	
<i>FNSL</i>	Meter selection	0: Output frequency 1: Output current 2: Set frequency 3: DC voltage 4: Output voltage command value 5: Input power 6: Output power 7: Torque 8: Torque current 9: Motor cumulative load factor 10: Inverter cumulative load factor 11: PBR (braking reactor) cumulative load factor 12: Frequency setting value (after PID) 13: VIA Input value 14: VIB Input value 15: Fixed output 1 (Output current: 100%) 16: Fixed output 2 (Output current: 50%) 17: Fixed output 3 (Other than the output current: 100%) 18: Serial communication data 19: For adjustments (<i>FN</i> set value is displayed.)	0	
<i>FN</i>	Meter adjustment	—	—	

2005 Ver.112/113

Title	Function	Adjustment range	Default setting	Remarks
<i>YP</i>	Default setting	0: - 1: 50Hz default setting 2: 60Hz default setting 3: Default setting (Initialization) 4: Trip record clear 5: Cumulative operation time clear 6: Initialization of type information 7: Save user-defined parameters 8: Call user-defined parameters 9: Cumulative fan operation time re-cord clears	0	
<i>Fr</i>	Forward/reverse run selection (Operation panel)	0: Forward run 1: Reverse run 2: Forward run (F/R switching possible) 3: Reverse run (F/R switching possible)	0	
<i>RCC</i>	Acceleration time 1	0.0-3200(s)	10.0	
<i>dEC</i>	Deceleration time 1	0.0-3200(s)	10.0	
<i>FH</i>	Maximum frequency	30.0-500.0(Hz)	80.0	
<i>UL</i>	Upper limit frequency	0.5- <i>FH</i> (Hz)	50(WP) 60(WN)	
<i>LL</i>	Lower limit frequency	0.0- <i>UL</i> (Hz)	0.0	
<i>uL</i>	Base frequency 1	25-500.0(Hz)	50(WP) 60(WN)	
<i>uLu</i>	Base frequency voltage 1	50-330(V) (240V class) 50-660(V) (500V/600V class)	230/ 460/ 575	
<i>Pt</i>	V/F control mode selection	0: V/F constant 1: Variable torque 2: Automatic torque boost control 3: Vector control 4: Automatic energy-saving 5: Dynamic automatic energy-saving (for fans and pumps) 6: PM motor control	0(WP) 2(WN)	
<i>ub</i>	Torque boost value 1	0.0-30.0(%)	—	Depends on the capacity
<i>EMr</i>	Motor electronic-thermal protection level 1	10-100(%/A)	100	
<i>OLn</i>	Electronic-thermal protection characteristic selection	Setting Type Overload protection OL stall 0 Standard motor Valid Invalid 1 Standard motor Valid Valid 2 Standard motor Invalid Invalid 3 Standard motor Invalid Valid 4 VF motor Valid Invalid 5 VF motor Valid Valid 6 VF motor Invalid Invalid 7 (Hz) Invalid Valid	0	
<i>Sr 1 to Sr 7</i>	Preset-speed operation frequency 1-7	<i>LL - UL</i> (Hz)	0.0	
<i>F--</i>	Extended parameters	—	—	
<i>Gr.U</i>	Automatic edit function	—	—	

To **Extended parameters** Nearly 200 parameters

How to read the monitor display?

Monitor display

The LEDs on the operation panel display the following symbols to indicate operations and parameters.

LED (number)

0	1	2	3	4	5	6	7	8	9	-
0	1	2	3	4	5	6	7	8	9	-

LED (alphabet)

Aa	Bb	C	c	Dd	Ee	Ff	Gg	H	h	I	i	Jj	Kk	Ll
A	b	C	c	d	E	F	G	H	h	i	i	J	K	L
Mm	Nn	O	o	Pp	Qq	Rr	Ss	Tt	Uu	Vv	Ww	Xx	Yy	Zz
n	n	O	o	P	q	r	S	t	U	u			y	

List of parameters

External dimensions

Extended parameters I

2005 Ver.112/113

Parameters for setting functions that cannot be fulfilled by basic parameters.

Input terminal functions assignment parameters

A variety of functions can be given to various compatible input terminals by assigning the function numbers for the parameter in the table below.

Title	Function	Adjustment range	Default setting
F 108	Always active function selection 1	0-75 (No function)	0
F 110	Always-active function selection 2	0-75 (ST)	1
F 111	Input terminal selection 1 (F)	0-75 (F)	2
F 112	Input terminal selection 2 (R)	0-75 (R)	3
F 113	Input terminal selection 3 (RES)	0-75 (RES)	10
F 114	Input terminal selection 4 (S1)	0-75 (SS1)	6
F 115	Input terminal selection 5 (S2)	0-75 (SS2)	7
F 116	Input terminal selection 6 (S3)	0-75 (SS3)	8
F 117	Input terminal selection 7 (VIB)	5-17 (SS4)	9
F 118	Input terminal selection 8 (VIA)	5-17 (AD2)	5

Input terminal functions list

Function No.	Function	Function No.	Function
0	No function	38	Frequency command forced switching
1	Standby	39	No.2 Switching of V/F setting
2	Forward run command	40	Combination of No. 5, 39 and 61
3	Reverse run command	41	Frequency UP signal input from external contacts
4	Jog run mode	42	Frequency DOWN signal input from external contacts
5	Acceleration/deceleration 2 pattern selection	43	Frequency UP/DOWN cancellation signal input from external contacts
6	Preset-speed command 1	44	Combination of No. 10 and 43
7	Preset-speed command 2	45	VIA input gain
8	Preset-speed command 3	46	Thermal trip stop signal input from external device
9	Preset-speed command 4	47	Inversion of No. 46
10	Reset command	48	Forced switching from remote to local control
11	Trip stop command from external input device	49	Operation holding (stop of 3-wire operation)
12	Switching of command mode and frequency setting mode	50	Forced switching of command mode and terminal board command
13	DC braking command	51	Display cancellation of the cumulative power amount (kWh)
14	PID control prohibited	52	Forced operation (factory configuration required)
15	Permission of parameter editing	53	Fire-speed control
16	Combination of No. 1 and 10	54	Coast stop (gate off)
17	Combination of No. 1 and 12	55	Inversion of No. 10
18	Combination of No. 2 and 4	56	Combination of No. 1 and 2
19	Combination of No. 3 and 4	57	Combination of No. 1 and 3
20	Combination of No. 2 and 5	58	Acceleration/deceleration 3 selection
21	Combination of No. 3 and 5	59	Combination of No. 2 and 58
22	Combination of No. 2 and 6	60	Combination of No. 3 and 58
23	Combination of No. 3 and 6	61	Forced switching of stall prevention level 2
24	Combination of No. 2 and 7	62	Holding of RY-RC terminal output
25	Combination of No. 3 and 7	63	Holding of OUT-NO terminal output
26	Combination of No. 2 and 8	64	Cancellation (clearing) of operation command from panel
27	Combination of No. 3 and 8	65	PID control integral value clear
28	Combination of No. 2 and 9	66	Combination of No. 1, 2 and 6
29	Combination of No. 3 and 9	67	Combination of No. 1, 3 and 6
30	Combination of No. 2, 5 and 6	68	Combination of No. 1, 2 and 7
31	Combination of No. 3, 5 and 6	69	Combination of No. 1, 3 and 7
32	Combination of No. 2, 5 and 7	70	Combination of No. 1, 2 and 8
33	Combination of No. 3, 5 and 7	71	Combination of No. 1, 3 and 8
34	Combination of No. 2, 5 and 8	72	Combination of No. 1, 2 and 9
35	Combination of No. 3, 5 and 8	73	Combination of No. 1, 3 and 9
36	Combination of No. 2, 5 and 9	74	Combination of No. 1, 2 and 4
37	Combination of No. 3, 5 and 9	75	Combination of No. 1, 3 and 4

Output terminal functions assignment parameters

A variety of functions can be given to various compatible output terminals by assigning the function numbers for the parameter in the table below.

Title	Function	Adjustment range	Default setting
F 130	Output terminal selection 1A (RY-RC)	0-255 (LOW)	4
F 131	Output terminal selection 2A (OUT-NO)	0-255 (RCH)	6
F 132	Output terminal selection 3 (FL)	0-255 (FL)	10
F 137	Output terminal selection 1B (RY-RC)	0-255 (always ON)	255
F 138	Output terminal selection 2B (OUT-NO)	0-255 (always ON)	255
F 139	Output terminal logic selection (RY-RC, OUT-NO)	0, 1, 2, 3	0

Output terminal functions list

Function No.	Function	Function No.	Function
0/1	Frequency lower limit	30/31	Ready for operation (including ST/RUN)
2/3	Frequency upper limit	32/33	Ready for operation (excluding ST/RUN)
4/5	Low-speed detection signal	34/35	Frequency VIB selection
6/7	completion of acceleration/deceleration signal	36/37	Fault signal (put out also at the time of a retry)
8/9	Designated frequency attainment signal	38/39	Specified data output
10/11	Failure signal (trip output)	40/41	Specified data output 2
12/13	Over-torque detection	42/43	Cumulative operation time alarm
14/15	Start/Stop	44/45	Parts replacement alarm
16/17	OL pre-alarm	46/47	Braking sequence output
18/19	Braking resistor overload pre-alarm	48/49	F terminal input signal
20/21	Over-torque detection pre-alarm	50/51	Inversion of R terminal input signal
22/23	pre-alarm	52/53	Signal in accordance of frequency command
24/25	Small-current detection	54/55	Undervoltage detection
26/27	Significant failure	56-253	Invalid settings, always OFF (ignored)
28/29	Insignificant failure	254	Always OFF
		255	Always ON

Note) For functions 0 to 55, even numbers are true logic and odd numbers are false logic.

Carrier frequency parameters

Set parameters related to deep carrier frequency motor noise.

Title	Function	Adjustment range	Default setting
F 300	PWM carrier frequency	2.0-16.0 (kHz)	12.0
F 312	Random mode	0: Invalid, 1: Automatic setting	0
F 316	Carrier frequency control mode selection	0, 1, 2, 3	1

Frequency command (terminal block) specialized parameters

Set characteristics if input frequency instruction is input from terminal block.

Title	Function	Adjustment range	Default setting
F 200	Frequency priority selection	0, 1	0
F 201	VIA input point 1 setting	0-100 (%)	0
F 202	VIA input point 1 frequency	0-500 (Hz)	0.0
F 203	VIA input point 2 setting	0-100 (%)	100
F 204	VIA input point 2 frequency	0-500 (Hz)	50 (WP) 60 (WN)
F 207	Frequency setting mode selection 2	0-6 (same as F 00d)	1
F 210	VIB input point 1 setting	0-100 (%)	0
F 211	VIB input point 1 frequency	0-500 (Hz)	0.0
F 212	VIB input point 2 setting	0-100 (%)	100
F 213	VIB input point 2 frequency	0-500 (Hz)	50 (WP) 60 (WN)
F 470	VIA input bias	—	—
F 471	VIA input gain	—	—
F 472	VIB input bias	—	—
F 473	VIB input gain	—	—

Input/output terminal function parameters

Set specific values for functions such as low-speed/signal output and speed arrival signal output.

Title	Function	Adjustment range	Default setting
F 100	Low-speed signal output frequency	0- FH (Hz)	0.0
F 101	Speed reach setting frequency	0- FH (Hz)	0.0
F 102	Speed reach detection band	0- FH (Hz)	2.5
F 109	Analog/logic input function selection (VIA/VIB terminal)	0-4	0
F 167	Frequency command agreement detection range	0- FH (Hz)	2.5

Protection parameters

Set protection operations, trip output and alarm output settings etc.

Title	Function	Adjustment range	Default setting
F 301	Auto-restart control selection	0, 1, 2, 3, 4	0
F 302	Regenerative power ride-through control (Deceleration stop)	0, 1, 2	0
F 303	Retry selection (number of times)	0: Invalid, 1-10 (times)	0
F 305	Overvoltage limit operation (Slowdown stop mode selection)	0, 1, 2, 3	2
F 307	Supply voltage correction (limitation of output voltage)	0, 1, 2, 3	3
F 601	Stall prevention level 1	10-199 (%A), 200 (Invalid)	150
F 602	Inverter trip retention selection	0, 1	0
F 603	Emergency stop selection	0, 1, 2	0
F 604	Emergency DC braking time	0-20 (s)	1.0
F 605	Output phase failure detection mode selection	0, 1, 2, 3, 4, 5	0
F 607	Motor 150%-overload time limit	10-2400 (s)	300
F 608	Input phase failure detection mode selection	0: Invalid, 1: Valid	1

Torque up parameters

Set to generate high torque to match load or motor.

Title	Function	Adjustment range	Default setting
F 400	Auto-tuning	0, 1, 2	0
F 401	Slip frequency gain	0-150 (%)	50
F 402	Automatic torque boost value	0-30 (%)	* 1
F 415	Motor rated current	0.1-100.0 (A)	* 1
F 416	Motor no-load current	10-90 (%)	* 1
F 417	Motor rated speed	100-32000 (min ⁻¹)	1710
F 418	Speed control response coefficient	1-150	40
F 419	Speed control stability coefficient	1-100	20

Panel display parameters

Set if changing units displayed or various display methods.

Title	Function	Adjustment range	Default setting
F 701	Unit selection	0: %, 1: A (ampere)/V (volt)	0
F 702	Free unit selection	0.00: Invalid, 0.01-200.0	0.00
F 705	Inclination characteristic of free unit display	0: Negative inclination, 1: Positive inclination	1
F 706	Free unit display bias	0- FH (Hz)	0.00
F 707	Free step 1 (pressing a panel key once)	0.00: Invalid, 0.01- FH (Hz)	0.00
F 708	Free step 2 (panel display)	0: Invalid, 1-255	0
F 710	Standard monitor display selection	0, 1, 2, 3, 4, 5, 6, 7	0
F 719	Canceled of operation command when standby terminal (ST) is turned off	0: Operation command canceled (cleared), 1: Operation command retained	1
F 721	Panel stop pattern	0: Slowdown stop, 1: Coast stop	0

* 1: Default values vary depending on the capacity.

Extended parameters II

2005 Ver.112/113

Parameters for setting higher functions.

DC Braking parameters

Title	Function	Adjustment range	Default setting
F 250	DC braking starting frequency	0.0- FH (Hz)	0.0
F 251	DC braking current	0-100 (%A)	50
F 252	DC braking time	0.0-20.0 (s)	1.0
F 254	Motor shaft fixing control	0: Invalid, 1: Valid (after DC braking)	0

Multi-stage speed run parameters

Title	Function	Adjustment range	Default setting
F 287	Preset-speed operation frequency 8	LL-UL (Hz)	0.0
F 288	Preset-speed operation frequency 9	LL-UL (Hz)	0.0
F 289	Preset-speed operation frequency 10	LL-UL (Hz)	0.0
F 290	Preset-speed operation frequency 11	LL-UL (Hz)	0.0
F 291	Preset-speed operation frequency 12	LL-UL (Hz)	0.0
F 292	Preset-speed operation frequency 13	LL-UL (Hz)	0.0
F 293	Preset-speed operation frequency 14	LL-UL (Hz)	0.0
F 294	Preset-speed operation frequency 15 (Fire-speed)	LL-UL (Hz)	0.0

Power generation braking parameters

Title	Function	Adjustment range	Default setting
F 304	Dynamic braking selection	0: Invalid, 1: Valid	0
F 308	Dynamic braking resistance	1.0-1000 (Ω)	* 1
F 309	Dynamic braking resistor capacity	0.01-30.00 (kW)	* 1

No. 2 motor parameters

Title	Function	Adjustment range	Default setting
F 170	Base frequency 2	25-500 (Hz)	50/60
F 171	Base frequency voltage 2	50-330 (V)/50-660 (V)	230/460/575
F 172	Torque boost value 2	0-30 (%)	* 1
F 173	Motor electronic-thermal protection level 2	10-100 (%A)	100
F 185	Stall prevention level 2	10-199 (%A), 200: Invalid	150

No. 2 and no. 3 acceleration/deceleration time setting parameters

Title	Function	Adjustment range	Default setting
F 500	Acceleration time 2	0.0-3200 (s)	10.0
F 501	Deceleration time 2	0.0-3200 (s)	10.0
F 502	Acceleration/deceleration 1 pattern	0: Linear, 1: S-pattern 1, 2: S-pattern 2	0
F 503	Acceleration/deceleration 2 pattern	0: Linear, 1: S-pattern 1, 2: S-pattern 2	0
F 504	Acceleration/deceleration 1, 2, 3 selection	1: Acc/dec 1, 2: Acc/dec 2, 3: Acc/dec 3	1
F 505	Acc/dec 1 and 2 switching frequency	0.0-UL (Hz)	0.0
F 506	S-pattern lower-limit adjustment amount	0-50 (%)	10
F 507	S-pattern upper-limit adjustment amount	0-50 (%)	10
F 510	Acceleration time 3	0.0-3200 (s)	10.0
F 511	Deceleration time 3	0.0-3200 (s)	10.0
F 512	Acceleration/deceleration 3 pattern	0: Linear, 1: S-pattern 1, 2: S-pattern 2	0
F 513	Acc/dec 2 and 3 switching frequency	0.0-UL (Hz)	0.0

Jog run parameters

Title	Function	Adjustment range	Default setting
F 260	Jog run frequency	F 240 - 20.0 (Hz)	5.0
F 261	Jog run stopping pattern	0, 1, 2	0
F 262	Panel jog run operation mode	0: Invalid, 1: Valid	0

Jump frequency parameters

Title	Function	Adjustment range	Default setting
F 270	Jump frequency 1	0- FH (Hz)	0.0
F 271	Jumping width 1	0-30 (Hz)	0.0
F 272	Jump frequency 2	0- FH (Hz)	0.0
F 273	Jumping width 2	0-30 (Hz)	0.0
F 274	Jump frequency 3	0- FH (Hz)	0.0
F 275	Jumping width 3	0-30 (Hz)	0.0

Forward/reverse/start frequency parameters

Title	Function	Adjustment range	Default setting
F 105	Priority selection (Both F-CC and R-CC are ON)	0: Reverse, 1: Slowdown Stop	1
F 240	Starting frequency setting	0.5-10 (Hz)	0.5
F 241	Operation starting frequency	0- FH (Hz)	0.0
F 242	Operation starting frequency hysteresis	0- FH (Hz)	0.0
F 256	Time limit for lower-limit frequency operation	0: Invalid, 0.1-600 (s)	0.1
F 311	Reverse-run prohibition	0, 1, 2	0

Analog/pulse train output setting parameters

Title	Function	Adjustment range	Default setting
F 669	Logic output/pulse train output selection (OUT-NO)	0: Logic output, 1: Pulse train output	0
F 676	Pulse train output function selection (OUT-NO)	0-17 (Same as F 05L)	0
F 677	Maximum numbers of pulse train	500-1600(PPS)	800
F 691	Inclination characteristic of analog output	0: Negative inclination, 1: Positive inclination	1

For inverter users

When studying how to use our inverters

Notes

Leakage current

This inverter uses high-speed switching devices for PWM control. When a relatively long cable is used for power supply to an inverter, current may leak from the cable or the motor to the ground because of its capacitance, adversely affecting peripheral equipment. The intensity of such a leakage current depends on the PWM carrier frequency, the lengths of the input and output cables, etc., of the inverter. To prevent current leakage, it is recommended to take the following measures.

[Effects of leakage current]

Leakage current which increases when an inverter is used may pass through the following routes:

- Route (1) ... Leakage due to the capacitance between the ground and the noise filter
 - Route (2) ... Leakage due to the capacitance between the ground and the inverter
 - Route (3) ... Leakage due to the capacitance between ground and the cable connecting the inverter and the motor
 - Route (4) ... Leakage due to the capacitance of the cable connecting the motor and an inverter in another power distribution line
 - Route (5) ... Leakage through the grounding line common to motors
 - Route (6) ... Leakage to another line because of the capacitance of the ground
- Leakage current which passes through the above routes may cause the following trouble.

- Malfunction of a leakage circuit breaker in the same or another power distribution line
- Malfunction of a ground-relay installed in the same or another power distribution line
- Noise produced at the output of an electronic device in another power distribution line
- Activation of an external thermal relay installed between the inverter and the motor, at a current below the rate current

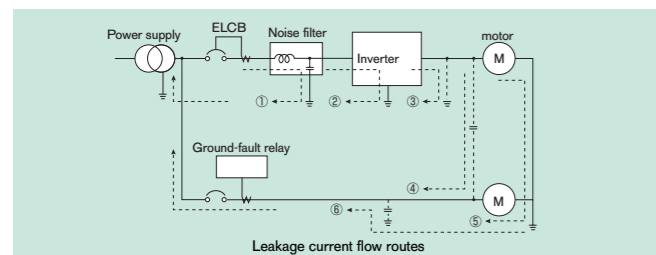

[Measures against effects of leakage current]

The measures against the effects of leakage current are as follows:

- 1) Measures to prevent the malfunction of leakage circuit breakers
 - (1) Decrease the PWM carrier frequency of the inverter. (Note)
 - (2) Use radio-frequency interference-proof ELCBs as ground-fault interrupters in not only the system into which the inverter is incorporated but also other systems. When ELCBs are used, the PWM carrier frequency needs to be increased to operate the inverter.
 - (3) When connecting multiple inverters to a single ELCB, use an ELCB with a high current sensitivity or reduce the number of inverters connected to the ELCB.
- 2) Measures against malfunction of ground-fault relay:
 - (1) Decrease the PWM carrier frequency of the inverter. (Note)
 - (2) Install ground-fault relays with a high-frequency protective function (e.g., Toshiba CCR12 type of relays) in both the same and other lines. When ELCBs are used, the PWM carrier frequency needs to be increased to operate the inverter.
- 3) Measures against noise produced by other electric and electronic systems:
 - (1) Separate the grounding line of the inverter from that of the affected electric and electronic systems.
 - (2) Decrease the PWM carrier frequency of the inverter. (Note)
- 4) Measures against malfunction of external thermal relays:
 - (1) Remove the external thermal relay and use the electronic thermal function of the inverter instead of it. (Unapplicable to cases where a single inverter is used to drive more than one motor. Refer to the instruction manual for measures to be taken when thermal relays cannot be removed.)
 - (2) Decrease the PWM carrier frequency of the inverter. (Note)
- 5) Measures by means of wiring and grounding
 - (1) Use a grounding wire as large as possible.
 - (2) Separate the inverter's grounding wire from that of other systems or install the grounding wire of each system separately to the grounding point.

- (3) Ground (shield) the main circuit wires with metallic conduits.
- (4) Use the shortest possible cables to connect the inverter to the motor.
- (5) If the inverter has a high-attenuation EMI filter, turn off the grounding capacitor detachment switch to reduce the leakage current. Note that doing so leads to a reduction in the noise attenuating effect.

Note) This inverter allows you to decrease the frequency up to 2.0kHz.

If the carrier frequency reduce, the acoustic noise caused by the motor increase.

Ground fault

Before beginning operation, thoroughly check the wiring between the motor and the inverter for incorrect wiring or short circuits. Do not ground the neutral point of any star-connected motor.

Radio interference

[Noise produced by inverters]

Since this inverter performs PWM control, it produces noise and sometimes affects nearby instrumental devices, electrical and electronic systems, etc. The effects of noise greatly vary with the noise resistance of each individual device, its wiring condition, the distance between it and the inverter, etc.

[Measures against noises]

According to the route through which noise is transmitted, the noises produced by an inverter are classified into transmission noise, induction noise and radiation noise.

[Examples of protective measures]

- Separate the power line from other lines, such as weak-current lines and signal lines, and install them apart from each other.
- Install a noise filter in each inverter. It is effective for noise prevention to install noise filters in other devices and systems, as well.
- Shield cables and wires with grounded metallic conduits, and cover electronic systems with grounded metallic cases.
- Separate the power distribution line of the inverter from that of other devices and systems.
- Install the input and output cables of the inverter apart from each other.
- Use shielded twisted pair wires for wiring of the weak-current and signal circuits, and always ground one of each pair of wires.
- Ground the inverter with grounding wires as large and short as possible, separately from other devices and systems.

The single-phase 240V and three-phase 500V models have built-in noise filters which significantly reduce noise.

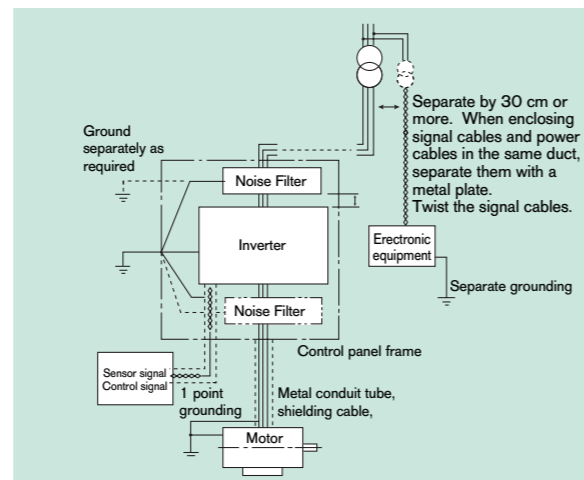

Power factor improvement capacitors

Do not install a power factor improvement capacitors on the input or output side of the inverter.

Installing a power factor improvement capacitor on the input or output side causes current containing harmonic components to flow into the capacitor, adversely affecting the capacitor itself or causing the inverter to trip. To improve the power factor, install an input AC reactor or a DC reactor (optional) on the primary side of the inverter.

Installation of input AC reactors

These devices are used to improve the input power factor and suppress high harmonic currents and surges. Install an input AC reactor when using this inverter under the following conditions:

- (1) When the power source capacity is 200kVA or more, and when it is 10 times or more greater than the inverter capacity.
- (2) When the inverter is connected the same power distribution system as a thyristor-committed control equipment.
- (3) When the inverter is connected to the same power distribution system as that of distorted wave-producing systems, such as arc furnaces and large-capacity inverters.

When wiring the inverter

Wiring precautions

Installing a molded-case circuit breaker [MCCB]

- (1) Install a molded-case circuit breaker (MCCB) on the inverter's power supply input to protect the wiring.
- (2) Avoid turning the molded-case circuit breaker on and off frequently to turn on/off the motor.
- (3) To turn on/off the motor frequently, close/break the control terminals F (or R)-CC.

Installing a magnetic contactor [MC] [primary side]

- (1) To prevent an automatic restart after the power interruption or overload relay has tripped, or actuation of the protective circuit, install an electro-magnetic contact in the power supply.
- (2) The inverter is provided with a failure detection relay (FL), so that, if its contacts are connected to the operation circuit of the magnetic contactor on the primary side, the magnetic contactor will be opened when the protective circuit of the inverter is activated.
- (3) The inverter can be used without a magnetic contactor. In this case, use an MCCB (equipped with a voltage tripping device) for opening the primary circuit when the inverter protective circuit is activated.
- (4) Avoid turning the magnetic contactor on and off frequently to turn on/off the motor.
- (5) To turn on/off the motor frequently, close/break the control terminals F (or R)-CC.

Installing a magnetic contactor [MC] [secondary side]

- (1) As a rule, if a magnetic contactor is installed between the inverter and the motor, do not turn ON/OFF while running. (If the secondary-side contactor is turned ON/OFF while running, a large current may flow in the inverter, causing inverter damage and failure.)
- (2) A magnetic contactor may be installed to change the motor or change to the commercial power source when the inverter is stopped. Always use an interlock with the magnetic contactor in this situation so that the commercial power supply is not applied to the inverter's output terminals.

External signal

- (1) Use a relay rated for low currents. Mount a surge suppressor on the excitation coil of the relay.
- (2) When wiring the control circuit, use shielded wires or twisted pair cables.
- (3) All control terminals, except FLA, FLB and FLC are electronic circuits. Therefore, input signal must insulate with power circuit.

Installing an overload relay

- (1) The VF-S11 inverter has an electronic-thermal overload protective function. However, in the following cases, the thermal relay operation level must be adjusted or an overload relay matching the motor's characteristics must be installed between the inverter and the motor.
 - (a) When using a motor having a rated current value different from that of the equivalent.
 - (b) When driving several motors simultaneously.
- (2) When using the inverter to control the operation of a constant-torque motor (VF motor), change the protective characteristic of the electronic thermal relay according to the setting of the VF motor.
- (3) In order to adequately protect a motor used for low-speed operation, we recommend the use of a motor equipped with an embedded thermal relay.

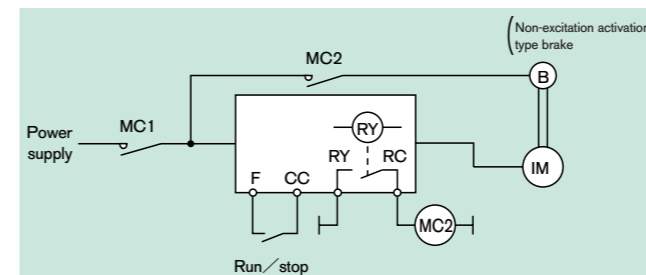

When changing the motor speed

Application to standard motors

Vibration

When a motor is operated with an industrial inverter, it experiences more vibrations than when it is operated by the commercial power supply. The vibration can be reduced to a negligible level by securing the motor and machine to the base firmly. If the base is weak, however, the vibration may increase at a light load due to resonance with the mechanical system.

Reduction gear, belt, chain

Note that the lubrication capability of a reducer or a converter used as the interface of the motor and the load machine may be affected at low speeds. When operating at a frequencies exceeding 60 Hz or higher, power transmission mechanisms such as reduction gear, belts and chains, may cause problems such as production of noise, a reduction in strength, or shortening of service life.

Frequency

Before setting the maximum frequency to 60 Hz or higher, confirm that this operating range is acceptable for the motor.

Application to special motors

Gear motor

When using an industrial inverter to drive a gear motor, inquire of the motor manufacturer about its continuous operation range, since low-speed operation of a gear motor may cause insufficient lubrication.

Toshiba Gold Motor (High-efficiency power-saving motor)

Inverter-driven operation of Toshiba Gold Motors is the best solution for saving energy. This is because these motors have improved efficiency, power factor, and noise/vibration reduction characteristics when compared to standard motors.

Pole-changing motor

Pole-changing motors can be driven by this inverter. Before changing poles, however, be sure to let the motor come to a complete stop.

Hight-pole-count motors

Note that hight-pole count motors(8 or more poles), which may be used for fans,etc., have higher rated current than 4-pole motors. The current ratings of multipole motors are relatively high. So, when selecting an inverter, you must pay special attention to its current rating so that the current rating of the motor is below that of the inverter.

Single-phase motor

Because single-phase motors are equipped with a centrifugal switch and capacitors for starting, they cannot be driven by an inverter. If only a single-phase, power system is available a 3-phase motor can be driven by using a single-phase input inverter to convert it into a 3-phase 240V output. (A special inverter and a 3-phase motor are required.)

Braking motor

When using a braking motor, if the braking circuit is directly connected to the inverters' output terminals, the brake cannot be released because of the lowered starting voltage. Therefore, when using a braking motor, connect the braking circuit to the inverter's power supply side, as shown on the left. Usually, braking motors produce larger noise in low speed ranges.

Note: In the case of the circuit shown on the left, assign the function of detecting low-speed signals to the RY and RC terminals. Make sure the parameter F130 is set to 4 (factory default setting).

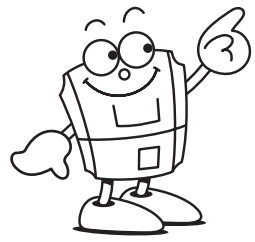

For inverter users

Selecting the capacity (model) of the inverter

Selection

Capacity

Refer to the applicable motor capacities listed in the standard specifications. When driving a high-pole motor, special motor, or multiple motors in parallel, select such an inverter that the sum of the motor rated current multiplied by 1.05 to 1.1 is less than the inverter's rated output current value.

Acceleration/deceleration times

The actual acceleration and deceleration times of a motor driven by an inverter are determined by the torque and moment of inertia² of the load, and can be calculated by the following equations.

The acceleration and deceleration times of an inverter can be set individually. In any case, however, they should be set longer than their respective values determined by the following equations.

Acceleration time	$t_a = \frac{(JM+JL) \times \Delta N}{9.56 \times (TM - TL)}$ (sec.)
Deceleration time	$t_d = \frac{(JM+JL) \times \Delta N}{9.56 \times (TB + TL)}$ (sec.)
Conditions	<p>JM : Moment of inertia of motor (kge.m²) JL : Moment of inertia of load (kge.m²) (converted into value on motor shaft) ΔN : Difference in rotating speed between before and after acc. or dec. (min.⁻¹) TL : Load torque (Ne.m) TM : Motor rated torque x 1.2-1.3 (Ne.m) ... V/f control : Motor rated torque x 1.5 (Ne.m) ... Vector operation control TB : Motor rated torque x 0.2 (Ne.m) (When a braking resistor or a braking resistor unit is used : Motor rated torque x 0.8-1.0 (Ne.m))</p>

Allowable torque characteristics

When a standard motor is combined with an inverter to perform variable speed operation, the motor temperature rises slightly higher than it normally does during commercial power supply operation. This is because the inverter output voltage has a sinusoidal (approximate) PWM waveform. In addition, the cooling becomes less effective at low speed, so the torque must be reduced according to the frequency.

When constant-torque operation must be performed at low speeds, use a Toshiba VF motor designed specifically for use with inverters.

[An example of V/f control at a base frequency of 60 Hz]

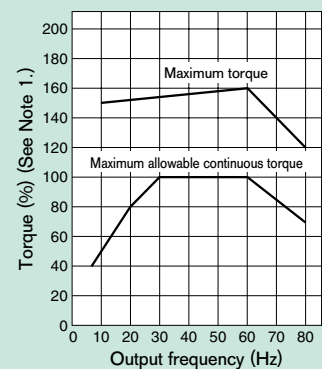

Note 1. 100% of torque refers to the amount of torque that the motor produces when it is running at a 60Hz-synchronized speed. The starting torque is smaller in this case than that required when power is supplied from a commercial power line. So, the characteristics of the machine to be operated need to be taken into consideration.

Note 2. The maximum allowable torque at 50Hz can be calculated approximately by multiplying the maximum allowable torque at a base frequency of 60Hz by 0.8.

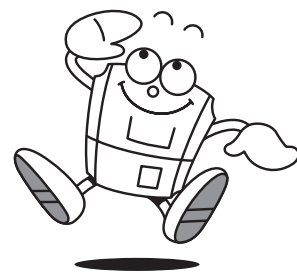

Starting characteristics

When a motor is driven by an inverter, its operation is restricted by the inverter's overload current rating, so the starting characteristic is different from those obtained from commercial power supply operation.

Although the starting torque is smaller with an inverter than with the commercial power supply, a high starting torque can be produced at low speeds by adjusting the V/f pattern torque boost amount or by employing vector control. (200% in sensorless control mode, though this rate varies with the motor characteristics.) When a larger starting torque is necessary, select an inverter with a larger capacity and examine the possibility of increasing the motor capacity.

Harmonic current and influence to power supply

Harmonics are defined as sinusoidal waves that is multiple frequency of commercial power (base frequency: 50Hz or 60Hz). Commercial power including harmonics has a distorted waveform.

Some electrical and electronic devices produce distorted waves in their rectifying and smoothing circuits on the input side. Harmonics produced by a device influence other electrical equipment and facilities in some cases (for example, overheating of phase advancing capacitors and reactors).

Measures for suppressing higher harmonics

No	Measures	Description
1	Connecting a reactor	The leakage of a harmonic current from an inverter can be restricted by connecting an input AC reactor (ACL) on the input side of the inverter or a DC reactor (DCL) to the DC section of the inverter.
2	Connecting a higher harmonic suppressing unit (SC7)	A PWM converter that shapes the waveform of an input current into a substantially sinusoidal waveform. The leakage of a harmonic current from a power supply can be restricted by connecting a harmonic suppressing unit (SC7).
3	Connecting a higher harmonic suppressing phase advancing capacitor	A harmonic current can be absorbed by the use of a phase advancing capacitor unit composed of a phase advancing capacitor and a DC reactor.
4	Multi-pulse operation of transformation	For delta-delta connection and delta-Y connection transformers, the effect of 12 pulses can be obtained by distributing the load evenly, and thus currents containing fifth-order and seventh-order harmonics can be suppressed.
5	Other measures	Harmonic currents can also be suppressed by the use of passive (AC) and active filters.

Peripheral devices

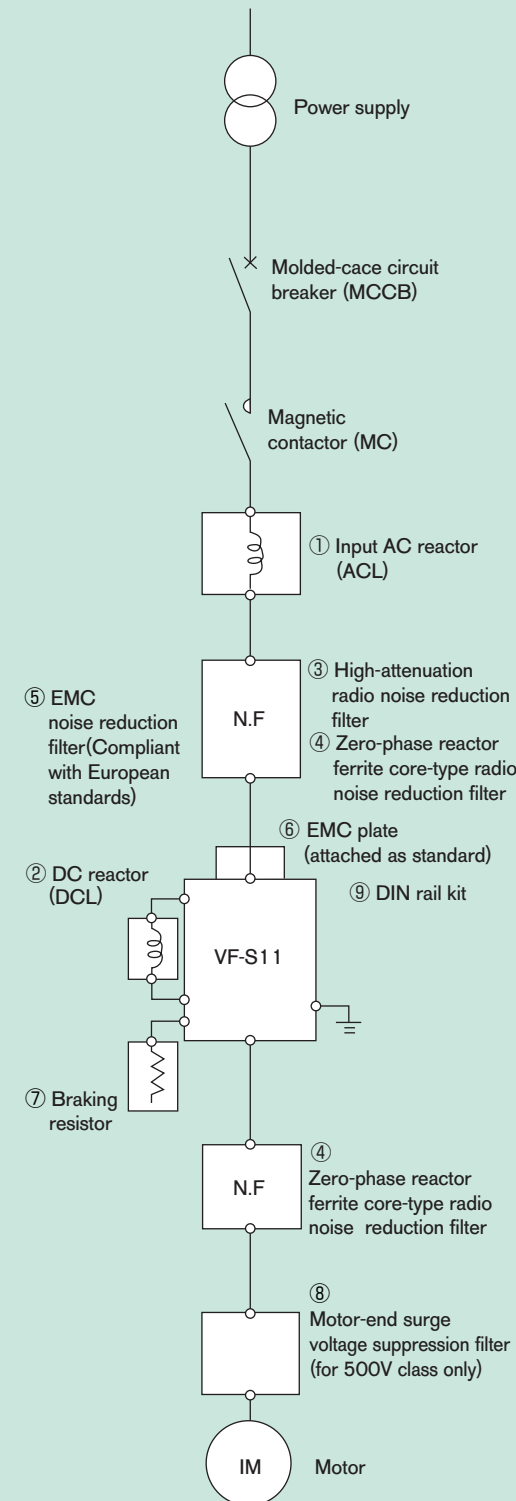

No.	Device	Function and purpose	Refer to
①	Input AC reactor (ACL)	Used to improve the input power factor, reduce the harmonics, and suppress external surge on the inverter power source side. Install when the power capacity is 200 kVA or more and 10 times or more than the inverter capacity or when a distorted wave generation source such as a thyristor unit or a large-capacity inverter is connected in the same distribution system.	P.17
②	DC reactor (DCL)	Generally, a DC reactor improves the power factor more than a DC reactor. When the inverter is used along with equipment for which a high degree of reliability is required, an input AC reactor capable of suppressing external surges should be used along with a DC reactor.	
③	High-attenuation radio noise filter (NF type)	These types of filters are not necessary because all single-phase 240V or 3-phase 500V models have a built-in EMI noise filter, conforming to Class A, as standard. But install these filters if necessarily of noise reduction move and more. <ul style="list-style-type: none"> Effective to prevent interference in audio equipment used near the inverter. Install on the input side of the inverter. Provided with wide-range attenuation characteristics from AM radio bands to near 10MHz. Use when equipment readily affected by noise is installed in the peripheral area. 	P.18
④	Zero-phase reactor ferrite core-type	<ul style="list-style-type: none"> Effective to prevent interference in audio equipment used near the inverter. Effective in noise reduction on both input and output sides of the inverter. Provided with attenuation characteristics of several dB in frequencies from AM radio bands to 10MHz. For noise countermeasures, insert on the secondary side of the inverter. 	P.18
⑤	EMC noise filter (Compliant with European standards)	A high-attenuation compact EMI noise filter that can be Foot-mounted and Side-mounted. With this filter on, the inverter complies with the following standards. Three-phase 240V model: EN55011: Class A, Group 1 (Motor connecting cable length: 5 m or less) And EN55011: Class B, Group 1 (Motor connecting cable length: 1 m or less) Single-phase 240V, three-phase 500V models: EN55011: Class B, Group 1 (Motor connecting cable length: 20 m or less) And EN55011: Class A, Group 1 (Motor connecting cable length: 50 m or less)	P.20
⑥	EMC plate (attached as standard)	A steel plate used to connect shielded earth wires from inverter's power cables or to connect earth wires from external devices.	P.9
⑦	Braking resistor	Use when rapid deceleration or stop is frequently required or when it is desired to reduce the deceleration time with large load. This resistor consumes regenerative energy during power generation braking. <ul style="list-style-type: none"> Braking resistor - With (resistor + protective thermal relay) built in. 	P.18
⑧	Motor-end surge voltage suppression filter (for 500V class only)	Use an insulation-reinforced motor or install the surge voltage restraint filter to prevent degrading motor insulation caused by surge voltage generation depending on cable length and wiring method, or use of a 400V class motor driven with an inverter.	P.19
⑨	DIN rail kit	Available for the 2.2kW (or 1.5kW) or less. (Model: DIN003Z, DIN005Z)	P.20
⑩	Parameter writer	Use this unit for batch read, batch copy, and batch writing of setting parameters. (Model: PWU001Z)	
⑪	Extension panel	Extended operation panel kit provided with LED indication section, RUN/STOP key, UP/DOWN key, Monitor key, and Enter key. (Model: RKPO01Z)	P.19
⑫	RS232C communication conversion cable	This unit allows you to connect a personal computer to inverters for data communications. (Model: RS20035)	
⑬	RS485 communication conversion unit	This unit allows you to connect a personal computer to multiple inverters for data transfer. (Models: RS4001Z, RS4002Z)	P.19
⑭	USB communication conversion unit	This unit is connected to a PLC or a computer to enable data communications. By connecting the connector cable, parameters can be easily adjusted, and data easily saved and written. (Type: USB 001Z)	-
⑮	Internal communication card	These boards allow you to connect an upper controller to multiple inverters for data transfer. Removable terminal board is replaced by these boards. RS485, DeviceNet and Lonworks are prepared. (Models: RS4003Z, DEV001Z, LIU005Z)	P.20
⑯	Remote panel	This panel includes a frequency meter, a frequency regulator and RUN/STOP (forward/reverse run) switches. (Model: CBVR-7B1)	P.19
⑰	Conduit pipe attachment kit	Attachment kit used for conformance to NEMA TYPE1.	-
⑱	Communication cable for totally enclosed box type	This cable allows you to connect a personal computer for the totally enclosed box type while retaining the protective construction of the IP54 (or IP55). (Type: CAB 0031)	-

Devices External dimensions and connections

Input AC reactor (ACL)

Model	Rating	Inverter type	Dimensions (mm)							Diagram	Terminals	Approx. weight (kg)
			A	B	C	D	E	F	G			
PFLS2002S	1-phase 240V-2.0A-50/60Hz	VFS11S-2002PL (Note)	80	55	115	63	45	5	45	A	Harmonica terminal M3.5	0.85
PFL2005S	3-phase 240V-5.5A-50/60Hz	VFS11-2004~2007PM VFS11S-2004PL	105	65	115	90	55	5	40		Harmonica terminal M3.5	1.2
PFL2011S	3-phase 240V-11A-50/60Hz	VFS11-2015, 2022PM VFS11S-2007PL	130	70	140	115	60	5	50	A	Harmonica terminal M4	2.3
PFL2018S	3-phase 240V-18A-50/60Hz	VFS11-2037PM VFS11S-2015, 2022PL	130	70	140	115	60	5	50		Harmonica terminal M4	2.5
PFL2025S	3-phase 240V-25A-50/60Hz	VFS11-2055PM	125	100	130	50	83	7	—	B	Harmonica terminal M4	2.6
PFL2050S	3-phase 240V-50A-50/60Hz	VFS11-2075, 2110PM	155	115	140	50	95	7	—		Harmonica terminal M6	3.4
PFL2100S	3-phase 240V-100A-50/60Hz	VFS11-2150PM	230	150	210	60	90	8	—	Harmonica terminal M8	8.2	
PFL4012S	3-phase 500V-12.5A-50/60Hz	VFS11-4004~4037PL	125	95	130	50	79	7	—	B	Harmonica terminal M4	2.3
PFL4025S	3-phase 500V-25A-50/60Hz	VFS11-4055~4110PL	155	110	155	50	94	7	—		Harmonica terminal M4	4.9
PFL4050S	3-phase 500V-50A-50/60Hz	VFS11-4150PL	155	140	165	50	112	7	—		Harmonica terminal M6	6.6

Note: PFLS2002S has 4 terminals.

DC reactor (DCL)

Model	Rated current (A)	Inverter type	Dimensions (mm)								Diagram	Terminals	Approx. weight (kg)
			W	H	D	X	Y	d1	d2				
DCLS-2002	2.5	VFS11S-2002PL	79	50	44	66	—	—	—	A	V1.25-3.5	0.6	
DCL-2007	7	VFS11-2004~2007PM VFS11S-2004PL	92	65	70	82	—	—	—		V2-3.5	1.2	
DCL-2022	14	VFS11-2015, 2022PM VFS11S-2007PL	86	110	80	71	64	—	—	B	M4	2.2	
DCL-2037	22.5	VFS11-2037PM VFS11S-2015, 2022PL	86	110	85	71	70	—	—		M4	2.5	
DCL-2055	38	VFS11-2055PM	75	130	140	50	85	85	55	C	M5	1.9	
DCL-2110	75	VFS11-2075~2110PM	100	150	150	65	85	95	55		M6	2.4	
DCL-2220	150	VFS11-2150PM	117	160	190	90	90	130	60	M8	4.3		
DCL-2007	7	VFS11-4004~4015PL (Note)	92	65	70	82	—	—	—	A	V2-3.5	1.2	
DCL-2022	14	VFS11-4022, 4037PL (Note)	86	110	80	71	64	—	—	B	M4	2.2	
DCL-4110	38	VFS11-4055~4110PL	95	150	165	70	90	105	60	C	M5	3.0	
DCL-4220	75	VFS11-4150PL	105	160	185	80	100	130	65		M8	3.7	

Note: VFS11-4004PL-4037PL are used DC reactor for 240V class.

Devices External dimensions and connections

High-attenuation radio noise filter (NF type)

Reactor model	Rated current (A)	Inverter type	Dimensions (mm)											Approx. weight (kg)	
			A	B	C	E	F	G	H	J	K	M	N		P
NF3005A-MJ	5	VFS11-2004PM~VFS11-2007PM	174.5	160	145	110	80	32	70	20	45	Ø5.5	M4	M4	1.0
NF3015A-MJ	15	VFS11-2015PM, VFS11-2022PM													
NF3020A-MJ	20	VFS11-2037PM	217.5	200	185	120	90	44	90	30	60	Ø6.5	M6	M4	1.6
NF3030A-MJ	30	VFS11-2055PM													
NF3040A-MJ	40	VFS11-2075PM	267.5	250	235	170	140	37	100	65	Ø6.5	M6	M4	2.7	
NF3050A-MJ	50	VFS11-2110PM													
NF3080A-MJ	80	VFS11-2150PM	294.5	280	260	170	150	44	70	20	43	Ø5.5	M4	M4	4.6
NF3010C-MJ	10	VFS11-4004~4037PL													
NF3015C-MJ	15	VFS11-4055PL	174.5	160	145	110	80	32	70	20	45	Ø5.5	M4	M4	1.4
NF3020C-MJ	20	VFS11-4075PL													
NF3030C-MJ	30	VFS11-4110PL	177.5	200	185	120	90	44	70	20	43	Ø5.5	M4	M4	7.0
NF3040C-MJ	40	VFS11-4150PL													

Note: Every inverter with a model number ending in-PL comes standard with a built-in noise filter almost equal in size and performance to this filter.

Zero-phase reactor ferrite core-type radio noise filter

Unit: mm





Input or output cable could be coiled over 4-times. RC5078 is recommended for the models 4.0kW or less.

Braking resistor

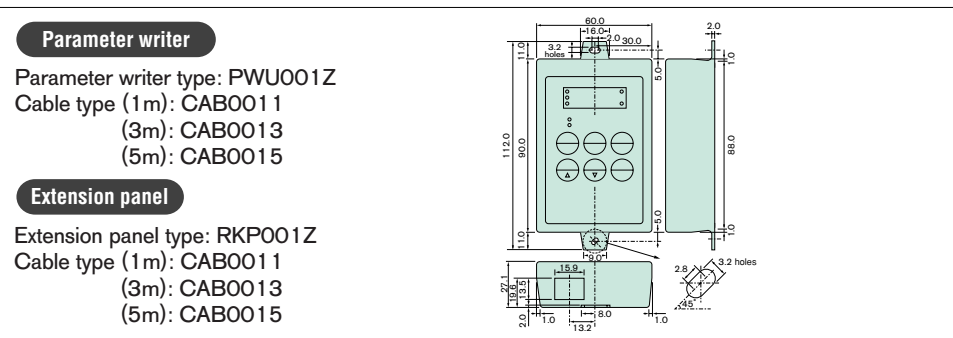
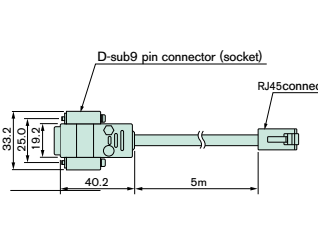
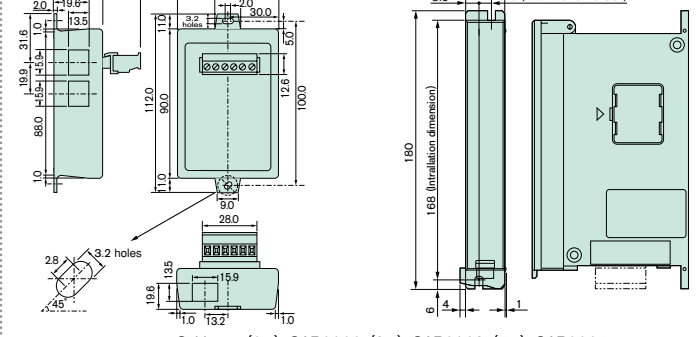
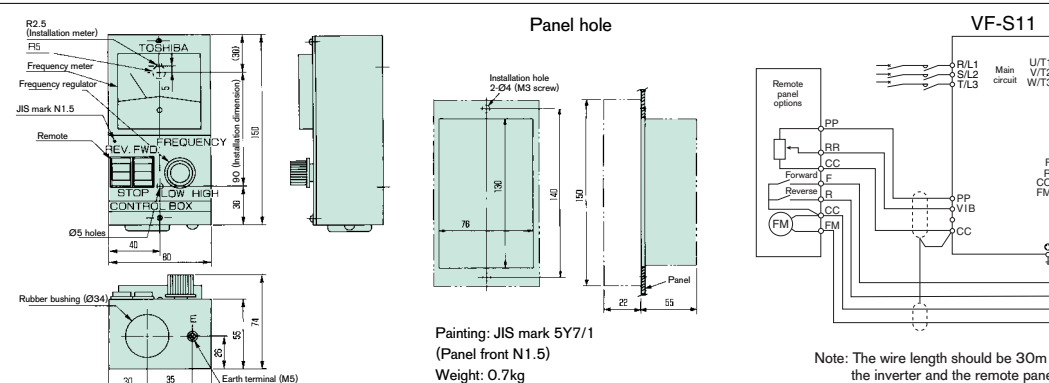
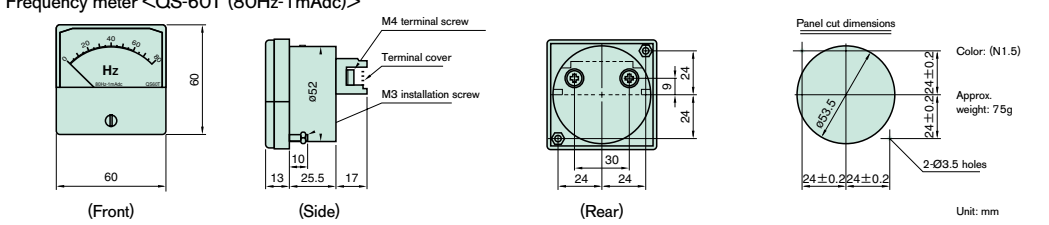
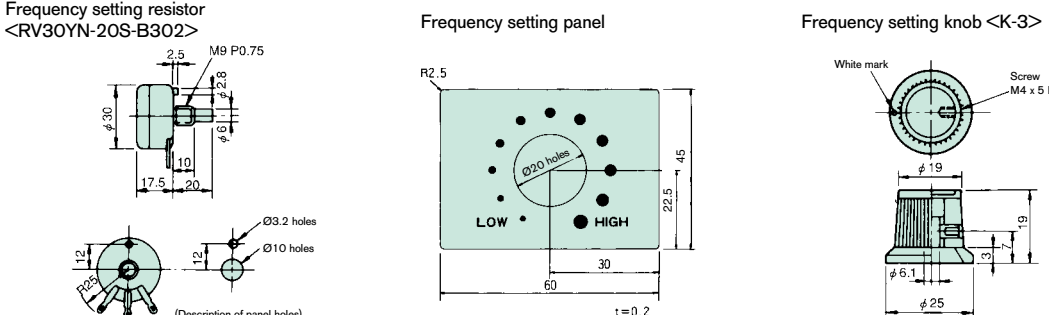
Model	Rating	Inverter type	Dimensions (mm)							External dimensions and connections	Approx. weight (kg)
			A	B	C	D	E	G			
PBR-2007	120W-200Ω	VFS11-2004~2007PM VFS11S-2002~2007PL	42	182	20	4.2	172	—	A and C	0.28	
PBR-2022	120W-75Ω	VFS11-2015, 2022PM VFS11S-2015, 2022PL									
PBR-2037	120W-40Ω	VFS11-2037PM									
PBR3-2055	240W-20Ω (40Ω × 2P)	VFS11-2055PM	120	320	115	110	230	150	B and D	4	
PBR3-2075	440W-15Ω (30Ω × 2P)	VFS11-2075PM									
PBR3-2110	660W-10Ω (30Ω × 3P)	VFS11-2110PM									
PBR3-2150	880W-7.5Ω (30Ω × 4P)	VFS11-2150PM									
PBR-2007	120W-200Ω	VFS11-4004~4022PL									
PBR-4037	120W-160Ω	VFS11-4037PL	42	182	20	4.2	172	—	A and C	0.28	
PBR3-4055	240W-80Ω (160Ω × 2P)	VFS11-4055PL									
PBR3-4075	440W-60Ω (120Ω × 2P)	VFS11-4075PL									
PBR3-4110	660W-40Ω (120Ω × 3P)	VFS11-4110PL									
PBR3-4150	880W-30Ω (120Ω × 4P)	VFS11-4150PL									

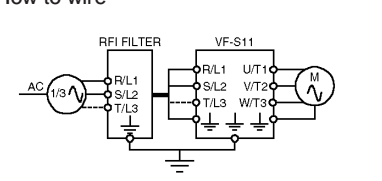
Note1: Use the same type of braking resistor of VFS11-2002 ~ 2007PM for those of VFS11-4004 ~ 4022PL.
Note2: The data in Rating above refer to the resultant resistance capacities (watts) and resultant re-resistance values (Ω).
The numeric values inside parentheses refer to the internal compositions of resistors.

Devices	External dimensions and connections							
Motor-end surge voltage suppression filter (for 500V class only)	Motor-end surge voltage suppression filter I	Inverter type	Dimensions (mm)			Terminal screw	Grounding screw	Approx. weight (kg)
	MSF-4015Z	VFS11-4004~4015PL	Width	Hight	Depth			
	MSF-4037Z	VFS11-4022, 4037PL	310	300	255	M4	M4	12
	MSF-4075Z	VFS11-4055, 4075PL	310	350	315	M5	M5	30
	MSF-4150Z	VFS11-4110, 4150PL	330	400	350	M5	M5	40
Parameter writer	<p>Parameter writer</p> <p>Parameter writer type: PWU001Z Cable type (1m): CAB0011 (3m): CAB0013 (5m): CAB0015</p>							
Extension panel	<p>Extension panel</p> <p>Extension panel type: RKP001Z Cable type (1m): CAB0011 (3m): CAB0013 (5m): CAB0015</p> 							
RS232C communication conversion cable	<p>RS232C communication converter cable Type: RS20035</p> 							
RS485 communication conversion unit	<p>RS485 communication converter unit</p> <p>·2-port type : RS4001Z</p> <p>·8-port type : RS4002Z</p>  <p>Cable type (1m): CAB0011, (3m): CAB0013, (5m): CAB0015</p>							
Remote panel CBVR-7B1	 <p>Painting: JIS mark 5Y7/1 (Panel front N1.5) Weight: 0.7kg</p> <p>Note: The wire length should be 30m or less the inverter and the remote panel.</p>							
Frequency meter QS60T	<p>Frequency meter <QS-60T (80Hz-1mAde)></p>  <p>Unit: mm</p>							
FRH kit	<p>Frequency setting resistor <RV30YN-20S-B302></p>  <p>(Description of panel holes)</p>							

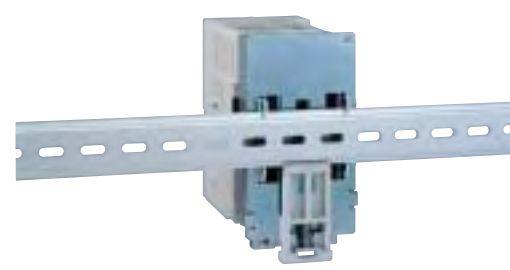
Devices	External dimensions and connections																																																																																																																																																																																																	
EMC noise reduction filter (Compliant with European standards)	Foot mount installation	Side mount installation	How to wire																																																																																																																																																																																															
			 <p>A high-attenuation compact EMI noise filter that can be Foot-mounted and Side-mounted. With this filter on, the inverter complies with the following standards.</p> <p>Three-phase 240V model: EN55011: Class A, Group 1 (Motor connecting cable length: 5 m or less) And EN55011: Class B, Group 1 (Motor connecting cable length: 1 m or less)</p> <p>Single-phase 240V, three-phase 500V models: EN55011: Class B, Group 1 (Motor connecting cable length: 20 m or less) And EN55011: Class A, Group 1 (Motor connecting cable length: 50 m or less)</p>																																																																																																																																																																																															
	<table border="1"> <thead> <tr> <th rowspan="2">Type</th> <th rowspan="2">Rated current</th> <th rowspan="2">Inverter type</th> <th colspan="7">Dimensions (mm)</th> <th rowspan="2">Approx. weight (kg)</th> <th colspan="2">Approx. leakage current (mA) Note 1)</th> </tr> <tr> <th>W</th> <th>H</th> <th>D</th> <th>W1</th> <th>H1</th> <th>E</th> <th>F</th> <th>G</th> <th>Power source A</th> <th>Power source B</th> </tr> </thead> <tbody> <tr> <td>EMFS11S-2009AZ</td> <td>9</td> <td>VFS11S-2002~2007PL</td> <td>72</td> <td>195</td> <td>37</td> <td>52</td> <td>180</td> <td>5</td> <td>8.5</td> <td>10</td> <td>0.5</td> <td>3</td> <td>47</td> </tr> <tr> <td>EMFS11-2007AZ</td> <td>7</td> <td>VFS11-2004~2007PM</td> <td>72</td> <td>195</td> <td>37</td> <td>52</td> <td>180</td> <td>5</td> <td>8.5</td> <td>10</td> <td>0.6</td> <td>7</td> <td>45</td> </tr> <tr> <td>EMFS11S-2016BZ</td> <td>16</td> <td>VFS11S-2015PL</td> <td>105</td> <td>195</td> <td>35</td> <td>85</td> <td>180</td> <td>5</td> <td>8.5</td> <td>10</td> <td>0.9</td> <td>3</td> <td>47</td> </tr> <tr> <td>EMFS11-4015BZ</td> <td>15</td> <td>VFS11-2015, 2022PM</td> <td>105</td> <td>195</td> <td>42</td> <td>85</td> <td>180</td> <td>5</td> <td>8.5</td> <td>10</td> <td>0.9</td> <td>8</td> <td>48</td> </tr> <tr> <td></td> <td></td> <td>VFS11-4004~4015PL</td> <td></td> <td></td> <td></td> <td></td> <td></td> <td></td> <td></td> <td></td> <td></td> <td>15</td> <td>96</td> </tr> <tr> <td>EMFS11S-2022CZ</td> <td>22</td> <td>VFS11S-2022PL</td> <td>140</td> <td>235</td> <td>35</td> <td>120</td> <td>215</td> <td>5</td> <td>8.5</td> <td>10</td> <td>0.8</td> <td>6</td> <td>103</td> </tr> <tr> <td>EMFS11-4025CZ</td> <td>25</td> <td>VFS11-2037PM</td> <td>140</td> <td>235</td> <td>50</td> <td>120</td> <td>215</td> <td>5</td> <td>8.5</td> <td>10</td> <td>1.3</td> <td>20</td> <td>125</td> </tr> <tr> <td></td> <td></td> <td>VFS11-4022, 4037PL</td> <td></td> <td></td> <td></td> <td></td> <td></td> <td></td> <td></td> <td></td> <td></td> <td>40</td> <td>249</td> </tr> <tr> <td>EMFS11-4047DZ</td> <td>47</td> <td>VFS11-2055, 2075PM</td> <td>180</td> <td>305</td> <td>60</td> <td>140</td> <td>285</td> <td>5.5</td> <td>9.5</td> <td>11</td> <td>2.6</td> <td>23</td> <td>147</td> </tr> <tr> <td></td> <td></td> <td>VFS11-4055, 4075PL</td> <td></td> <td></td> <td></td> <td></td> <td></td> <td></td> <td></td> <td></td> <td></td> <td>47</td> <td>293</td> </tr> <tr> <td>EMFS11-2083EZ</td> <td>83</td> <td>VFS11-2110, 2150PM</td> <td>245</td> <td>395</td> <td>80</td> <td>205</td> <td>375</td> <td>5.5</td> <td>9.5</td> <td>11</td> <td>5.0</td> <td>17</td> <td>104</td> </tr> <tr> <td>EMFS11-4049EZ</td> <td>49</td> <td>VFS11-4110, 4150PL</td> <td>245</td> <td>395</td> <td>60</td> <td>205</td> <td>375</td> <td>5.5</td> <td>9.5</td> <td>11</td> <td>3.8</td> <td>47</td> <td>293</td> </tr> </tbody> </table> <p>Note 1. These values are referential ones of single piece of RFI filter. For 240V class, 60Hz/200V power source. For 500V class, 60Hz/400V power source. For power system A and B, refer to table below. Select an earth leakage breaker with consideration of leakage current above and leakage current from the inverter unit.</p>			Type	Rated current	Inverter type	Dimensions (mm)							Approx. weight (kg)	Approx. leakage current (mA) Note 1)		W	H	D	W1	H1	E	F	G	Power source A	Power source B	EMFS11S-2009AZ	9	VFS11S-2002~2007PL	72	195	37	52	180	5	8.5	10	0.5	3	47	EMFS11-2007AZ	7	VFS11-2004~2007PM	72	195	37	52	180	5	8.5	10	0.6	7	45	EMFS11S-2016BZ	16	VFS11S-2015PL	105	195	35	85	180	5	8.5	10	0.9	3	47	EMFS11-4015BZ	15	VFS11-2015, 2022PM	105	195	42	85	180	5	8.5	10	0.9	8	48			VFS11-4004~4015PL										15	96	EMFS11S-2022CZ	22	VFS11S-2022PL	140	235	35	120	215	5	8.5	10	0.8	6	103	EMFS11-4025CZ	25	VFS11-2037PM	140	235	50	120	215	5	8.5	10	1.3	20	125			VFS11-4022, 4037PL										40	249	EMFS11-4047DZ	47	VFS11-2055, 2075PM	180	305	60	140	285	5.5	9.5	11	2.6	23	147			VFS11-4055, 4075PL										47	293	EMFS11-2083EZ	83	VFS11-2110, 2150PM	245	395	80	205	375	5.5	9.5	11	5.0	17	104	EMFS11-4049EZ	49	VFS11-4110, 4150PL	245	395	60	205	375	5.5	9.5	11	3.8	47	293
Type	Rated current	Inverter type	Dimensions (mm)							Approx. weight (kg)	Approx. leakage current (mA) Note 1)																																																																																																																																																																																							
			W	H	D	W1	H1	E	F		G	Power source A	Power source B																																																																																																																																																																																					
EMFS11S-2009AZ	9	VFS11S-2002~2007PL	72	195	37	52	180	5	8.5	10	0.5	3	47																																																																																																																																																																																					
EMFS11-2007AZ	7	VFS11-2004~2007PM	72	195	37	52	180	5	8.5	10	0.6	7	45																																																																																																																																																																																					
EMFS11S-2016BZ	16	VFS11S-2015PL	105	195	35	85	180	5	8.5	10	0.9	3	47																																																																																																																																																																																					
EMFS11-4015BZ	15	VFS11-2015, 2022PM	105	195	42	85	180	5	8.5	10	0.9	8	48																																																																																																																																																																																					
		VFS11-4004~4015PL										15	96																																																																																																																																																																																					
EMFS11S-2022CZ	22	VFS11S-2022PL	140	235	35	120	215	5	8.5	10	0.8	6	103																																																																																																																																																																																					
EMFS11-4025CZ	25	VFS11-2037PM	140	235	50	120	215	5	8.5	10	1.3	20	125																																																																																																																																																																																					
		VFS11-4022, 4037PL										40	249																																																																																																																																																																																					
EMFS11-4047DZ	47	VFS11-2055, 2075PM	180	305	60	140	285	5.5	9.5	11	2.6	23	147																																																																																																																																																																																					
		VFS11-4055, 4075PL										47	293																																																																																																																																																																																					
EMFS11-2083EZ	83	VFS11-2110, 2150PM	245	395	80	205	375	5.5	9.5	11	5.0	17	104																																																																																																																																																																																					
EMFS11-4049EZ	49	VFS11-4110, 4150PL	245	395	60	205	375	5.5	9.5	11	3.8	47	293																																																																																																																																																																																					
Internal communication card	<p>RS485 Type:RS4003Z</p> 	<p>DeviceNet Type:DEV001Z</p> 	<p>LONWORKS Type:LIU005Z</p> 																																																																																																																																																																																															
DIN rail kit	<table border="1"> <thead> <tr> <th>Type</th> <th>Inverter type</th> <th>Approx. weight (kg)</th> </tr> </thead> <tbody> <tr> <td rowspan="2">DIN003Z</td> <td>VFS11S-2002PL~2007PL</td> <td rowspan="2">0.2</td> </tr> <tr> <td>VFS11-2004PM~2007PM</td> </tr> <tr> <td rowspan="3">DIN005Z</td> <td>VFS11S-2015PL</td> <td rowspan="3">0.3</td> </tr> <tr> <td>VFS11-2015PM, 2022PM</td> </tr> <tr> <td>VFS11-4004PL~4015PL</td> </tr> <tr> <td></td> <td>VFS11-6007P, 6015P</td> <td></td> </tr> </tbody> </table> 			Type	Inverter type	Approx. weight (kg)	DIN003Z	VFS11S-2002PL~2007PL	0.2	VFS11-2004PM~2007PM	DIN005Z	VFS11S-2015PL	0.3	VFS11-2015PM, 2022PM	VFS11-4004PL~4015PL		VFS11-6007P, 6015P																																																																																																																																																																																	
Type	Inverter type	Approx. weight (kg)																																																																																																																																																																																																
DIN003Z	VFS11S-2002PL~2007PL	0.2																																																																																																																																																																																																
	VFS11-2004PM~2007PM																																																																																																																																																																																																	
DIN005Z	VFS11S-2015PL	0.3																																																																																																																																																																																																
	VFS11-2015PM, 2022PM																																																																																																																																																																																																	
	VFS11-4004PL~4015PL																																																																																																																																																																																																	
	VFS11-6007P, 6015P																																																																																																																																																																																																	

Totally enclosed box type

Possible to bring into compliance with IP55 specifications!

<UL compliant type>

- Operation panel
- Frequency setting potentiometer
- Operation switch
- Slots for additional switches (Two)
- Power switch for motor circuit breaker

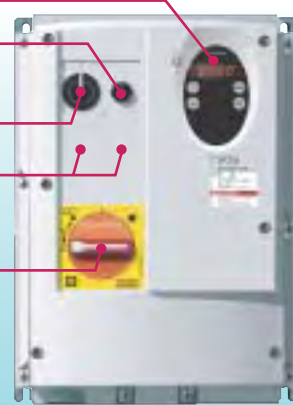

Line-up

Input voltage class	Applicable motor (kW)									
	0.2	0.4	0.75	1.5	2.2	4.0	5.5	7.5	11	15
1-phase 240V	IP54									
3-phase 240V	IP54									
3-phase 500V	IP54				IP00					

- Totally enclosed structure compliant with IP54
- Built-in noise filter
- Equipped with all control devices as standard (Control devices compliant with IP55 specifications / All-in-one)
- Built-in motor circuit breaker
- Minimum wiring
- Cooling structure: Self-cooling type

External dimensions

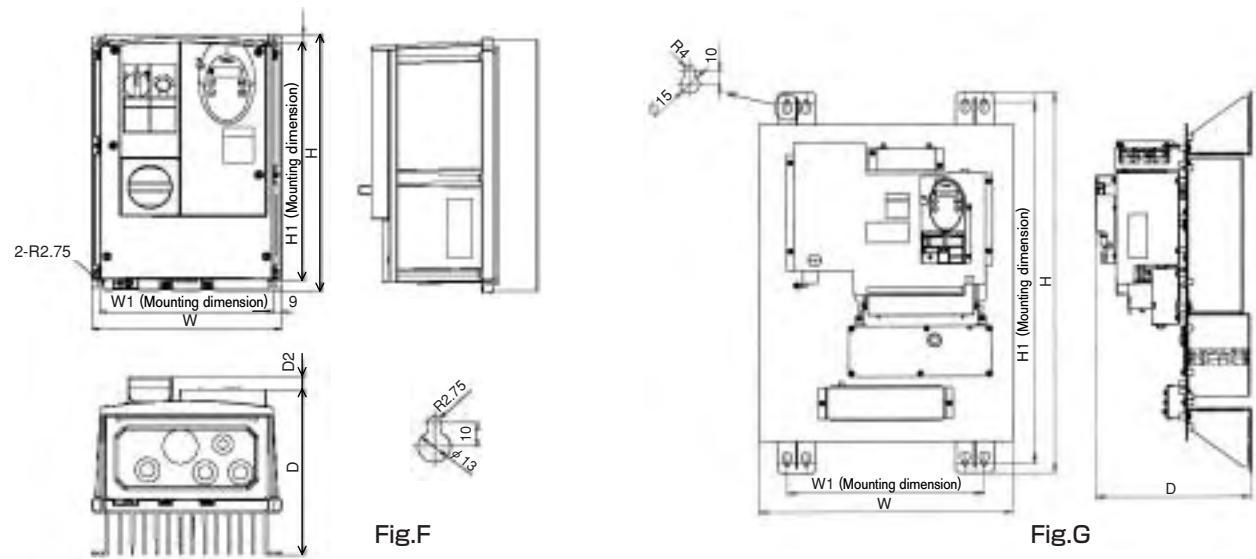

External dimensions

Input voltage class	Applicable motor (kW)	Inverter type	Dimensions (mm)						Cabling hole	Drawing	Approx. weight (kg)
			W	H	D	W1	H1	D2			
3ph-240V	0.4	VFS11-2004PME	210	240	163.3	192	218	13.7	φ 19x3 φ 21x1	F	3.9
	0.75	VFS11-2007PME									
	1.5	VFS11-2015PME	215	297	192.3	197	277	13.7	φ 19x1 φ 23x3	F	5.9
	2.2	VFS11-2022PME									7.6
3ph-500V	0.75	VFS11-4007PLE	215	297	192.3	197	277	13.7	φ 19x1 φ 23x3	F	6.1
	1.5	VFS11-4015PLE									
	2.2	VFS11-4022PLE	230	340	208.3	212	320	13.7		F	8.0
	4.0	VFS11-4037PLE									
	5.5	VFS11-4055PLU	400	600	243	310	570	-		G	11.8
	7.5	VFS11-4075PLU									
1ph-240V	11	VFS11-4110PLU	450	700	267	340	670	-		G	17.0
	15	VFS11-4150PLU									
	0.2	VFS11S-2002PLE									
	0.4	VFS11S-2004PLE	210	240	163.3	192	218	13.7	φ 19x3 φ 21x1	F	4.0
1ph-240V	0.75	VFS11S-2007PLE									
	1.5	VFS11S-2015PLE	215	297	192.3	197	277	13.7	φ 19x1 φ 23x3	F	6.0
	2.2	VFS11S-2022PLE	230	340	208.3	212	320	13.7		F	7.6

Standard specifications

Item	Specification																																																						
	1ph-240V input class / 3ph-240V input class / 3ph-500V input class					3ph-500V input class																																																	
Input voltage class	0.2					0.4					0.75					1.5					2.2					4.0					5.5					7.5					11					15									
Applicable motor (kW)																																																							
Model	Input voltage class	Type	Form																																																				
		1ph-240V class	VFS11S-	2002PLE	2004PLE	2007PLE	2015PLE	2022PLE	-	-	-	-	-	-	-	-	-	-	-	-	-																																		
	3ph-240V class	VFS11-	-	2004PME	2007PME	2015PLME	2022PME	2037PME	-	-	-	-	-	-	-	-	-	-	-	-	-																																		
	3ph-500V class	VFS11-	-	-	4007PLE	4015PLE	4022PLE	4037PLE	4055PLU	4075PLU	4110PLU	4150PLU	-	-	-	-	-	-	-	-	-																																		
Rating	Capacity(kVA) Note 1)	0.6					1.3					1.8					3.0/3.0/3.1					4.2					6.7/7.2					11					13					21					25								
	Rated output current (A) Note 2)	1ph-240V class	1.5 (1.5)					3.3 (3.3)					4.8 (4.4)					8.0 (7.9)					11.0 (10.0)					-					-					-					-												
		3ph-240V class	-					3.3 (3.3)					4.8 (4.4)					8.0 (7.9)					11.0 (10.0)					17.5 (16.4)					-					-					-												
		3ph-500V class	-					-					2.3 (2.1)					4.1 (3.7)					5.5 (5.0)					9.5 (8.6)					14.3 (13.0)					17.0 (17.0)					27.7 (25.0)					33 (30)							
Output voltage Note 3)	240V class : 3ph-200V to 240V, 500V class : 3ph-380V to 500V															3ph-380V to 500V																																							
Overload current rating	150% -60 seconds, 200% -0.5 second															150% -60 seconds, 200% -0.5 second																																							
Power supply	Voltage-frequency	240V class : 1ph/3ph-200V to 240V -50/60Hz, 500V class : 3ph-380V to 500V -50/60Hz															3ph-380V to 500V -50/60Hz																																						
	Allowable fluctuation	Voltage +10%, -15% Note4), frequency ±5%															Voltage +10%, -15% Note4), frequency ±5%																																						
Protective method	IP54 Totally enclosed type (JEM1030) / Possible to bring into compliance with IP55															IP00 Open type (JEM1030) / Cooling fin mountable out side																																							
Cooling method	Self-cooling															Forced air-cooling																																							
Color	Munsel 5Y-8/0.5															Not painted																																							
Built-in filter	1ph and 500V class : High-attenuation EMI filter, 3ph-240V class : Basic filter															High-attenuation EMI filter																																							
Environments	Service environments Note 6)	Indoor, altitude 1000m or less. Place not exposed to direct sunlight and free from of corrosive and explosive gases.																																																					
	Ambient temperature	-10 to +40°C															-10 to +40°C																																						
	Storage temperature	-25 to +70°C															-25 to +70°C																																						
	Relative humidity	20 to 93%															20 to 93%																																						
	Vibration	5.9 m/s ² or less (10 to 55Hz)															5.9 m/s ² or less (10 to 55Hz)																																						

Note 1: Capacity is calculated at 220V for the 240V class and at 440V for the 500V class.
 Note 2: Indicates rated output current setting when the PWM carrier frequency (Parameter F300) is 4kHz or less. When exceeding 4kHz, the rated output current setting is indicated in the parenthesis.
 Note 3: The maximum output voltage is equal to the input supply voltage.
 Note 4: ±10% when the inverter is operated continuously (under a load of 100%).
 Note 5: The factory default settings of the following parameters are different from those of the standard type. The factory default settings of all other parameters are the same as those of the standard type. For parameter settings, see the tables of parameters on page 10. periodically.

Title	Function	VF-S11 Standard type	VF-S11 totally enclosed type
CMOD	Command mode selection	1	0
FMOD	Frequency setting mode selection	0	2

Note 6: Installation environment
 - Install the inverter in a well-ventilated place and mount it on a flat metal plate in portrait orientation. Install the inverter so that it is not inclined more than ±10° from the vertical.
 - Leave a space of 10 cm or more on the upper and lower sides of the inverter, and a space of 5 cm or more on each side.
 - The inverter has a cooling fan to circulate air in it. The cooling fan has a useful life of approximately 30,000 hours (2 to 3 years when operated continuously), so it needs to be replaced periodically.

Compliance with IP55

IP54-compliant structures refer to structures that protect the contents from dust and harmful effects of water that drops from every direction. The inverter can be brought into compliance with IP55 specifications by making the wiring port watertight. (IP55-compliant structures refer to structures that protect the contents from dust and harmful effects of water that comes in a jet from every direction.)

Note) 500V class 5.5 to 15kW range are IP00 type.

Standard connection diagram

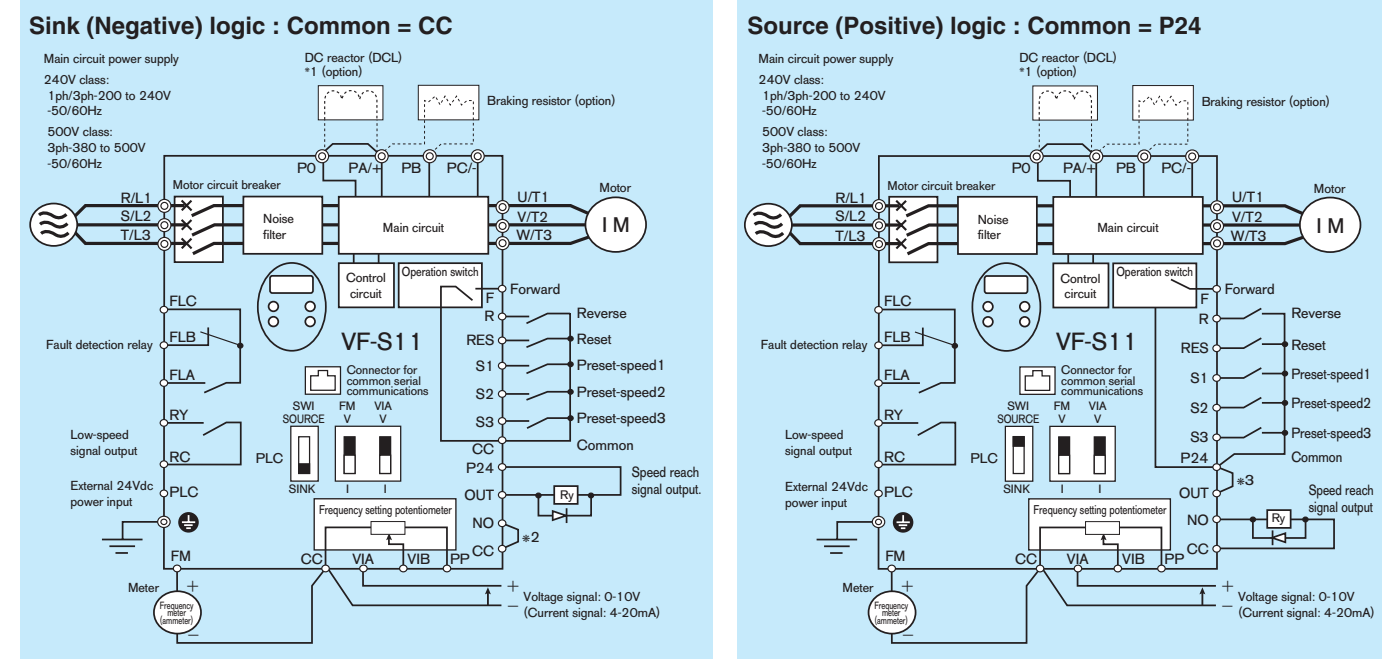

*1: The inverter comes with the PO and PA (positive) terminals short-circuited with a shorting bar. When connecting a DC reactor (DCL), detach the shorting bar.
 *2: When using the OUT output terminal in a sink logic configuration, do not short-circuit the NO and CC terminals.
 *3: When using the OUT output terminal in a sink logic configuration, do not short-circuit the P24 and OUT terminals.

Totally enclosed box type

Totally enclosed box type